

OWNER'S MANUAL

How to install, operate and maintain your
EcoWater Systems
Air Aspirated Iron Filter

ECOWATER
S Y S T E M S®



Your Water. Perfected.

Models

ETF2300AIV10

ETF2300AIV12

ETF2300EIV10

ETF2300EIV12

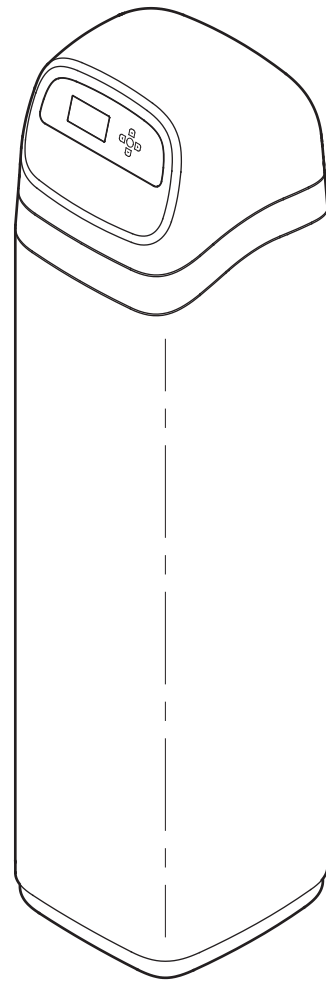

ETF2300AIV10 and ETF2300AIV12 are tested and certified by the Water Quality Association against NSF/ANSI Standard 372 for low lead content.

ETF2300EIV10 and ETF2300EIV12 are tested and certified without media by the Water Quality Association against CSA B483.1, NSF/ANSI 61, and NSF/ANSI Standard 372 for low lead content.



Designed, Engineered &
Assembled in the U.S.A.

EcoWater Systems LLC
P.O. Box 64420, St. Paul, MN 55164-0420
www.ecowater.com

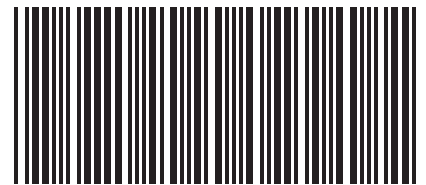

7355286 (Rev. J 3/26/20)

TABLE OF CONTENTS

	<u>Page</u>
Specifications & Dimensions	3
Before Starting Installation	4
Media Loading (EIV Models)	5
Typical Installation Illustrations	6
Installation	7-8
Description of Operation	9
Sanitizing Procedure	9
Setup Procedure	10-13
Filter Operation	14-25
Service Information	26-31
Troubleshooting Guide	28
Wiring Schematic	31
Repair Parts	33-35
Warranty	36

SAFETY GUIDES

Follow the installation instructions carefully. Failure to install the water filtration system properly **voids the warranty.**

Before you begin installation, read this entire manual. Then, obtain all the materials and tools you will need to make the installation.

Check local plumbing and electrical codes. The installation must conform to them.

Use only lead-free solder and flux for all sweat-solder connections, as required by state and federal codes.

Use care when handling the water filtration system. Do not turn upside down, drop, or set on sharp protrusions.

Do not locate the water filtration system where freezing temperatures occur. Do not attempt to treat water over 120°F. **Freezing, or hot water damage voids the warranty.**

The water filtration system requires a minimum water pressure of 30 psi at the inlet. **Maximum allowable inlet water pressure is 125 psi.** If daytime pressure is over 80 psi, nighttime pressure may exceed the maximum. Use a pressure reducing valve if necessary (Adding a pressure reducing valve may reduce the flow).

The water filtration system works on **24V DC** electrical power, supplied by a direct plug-in power supply (included). Be sure to use the included power supply, and plug it into a nominal **120V, 60 Hz** household outlet that is in a **dry location only**, grounded and properly protected by an overcurrent device such as circuit breaker or fuse.

This system is not intended to be used for treating water that is microbiologically unsafe or of unknown quality without adequate disinfection before or after the system.

FCC NOTICE

NOTE: This equipment has been tested and found to comply with the limits for a Class B digital device, pursuant to Part 15 of the **FCC** Rules. These limits are designed to provide reasonable protection against harmful interference in a residential installation. This equipment generates, uses, and can radiate radio frequency energy and, if not installed and used in accordance with the instructions may cause harmful interference to radio communications. However, there is no guarantee that interference will not occur in a particular installation. If this equipment does cause harmful interference to radio or television reception, which can be determined by turning the equipment off and on, the user is encouraged to try to correct the interference by one or more of the following measures:

- Reorient or relocate the receiving antenna.
- Increase the separation between the equipment and receiver.
- Connect the equipment into an outlet on a circuit different from that to which the receiver is connected.
- Consult the dealer or an experienced radio/TV technician for help.

Changes or modifications not expressly approved by EcoWater Systems could void the user's authority to operate the equipment.

This device complies with **Industry Canada** Standard RSS-210. Operation is subject to the following two conditions: (1) this device may not cause interference, and (2) this device must accept any interference, including interference that may cause undesired operation of the device.

Ce dispositif est conforme avec la norme CNR-210 **d'Industrie Canada**. Le fonctionnement du dispositif est sujet aux deux conditions suivantes: (1) le dispositif ne doit pas causer de brouillage, et (2) le dispositif doit accepter tous brouillages, incluant tous brouillages qui peut nuire au bon fonctionnement du dispositif.



European Directive 2002/96/EC requires all electrical and electronic equipment to be disposed of according to Waste Electrical and Electronic Equipment (WEEE) requirements. This directive or similar laws are in place nationally and can vary from region to region. Please refer to your state and local laws for proper disposal of the equipment.

SPECIFICATIONS				
Model	ETF2300AIV10	ETF2300AIV12	ETF2300EIV10	ETF2300EIV12
Model Code	HAIV0	HAIV2	HEIV0	HEIV2
Amount of Zeolite Media	1.0 cu. ft.	2.0 cu. ft.	—	—
Amount of Quartz Gravel	17 lbs.	29 lbs.	17 lbs.	29 lbs.
Flow Rate	7 - 10 gpm	9 - 15 gpm	7 - 10 gpm	9 - 15 gpm
Minimum Backwash Flow Rate	7 gpm*	10 gpm*	7 gpm***	10 gpm***
Maximum Supply Water Pressure	80 psi			
Water Temperature Limits (min./max.)	40 - 120 °F (4 - 49 °C)			
Contaminant Removal Limitations	Up to 10 ppm iron (except bacterial and organically bound iron**)		Consult media specifications for contaminant limitations	

*Well pump must be able to provide the minimum flow for 30+ minutes.

**Consult manufacturer for applications with bacterial or organically bound iron.

***Install a backwash flow control that is appropriately sized for the media used.

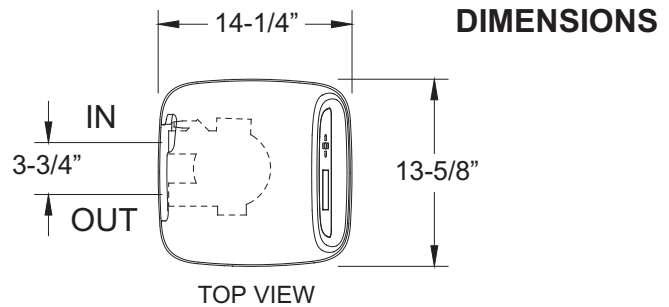

Model	Nominal Mineral Tank Size	Dimension A	Dimension B
ETF2300AIV10 ETF2300EIV10	10" Dia. x 47"	57"	50"
ETF2300AIV12 ETF2300EIV12	12" Dia. x 54"	62-1/4"	55-1/4"

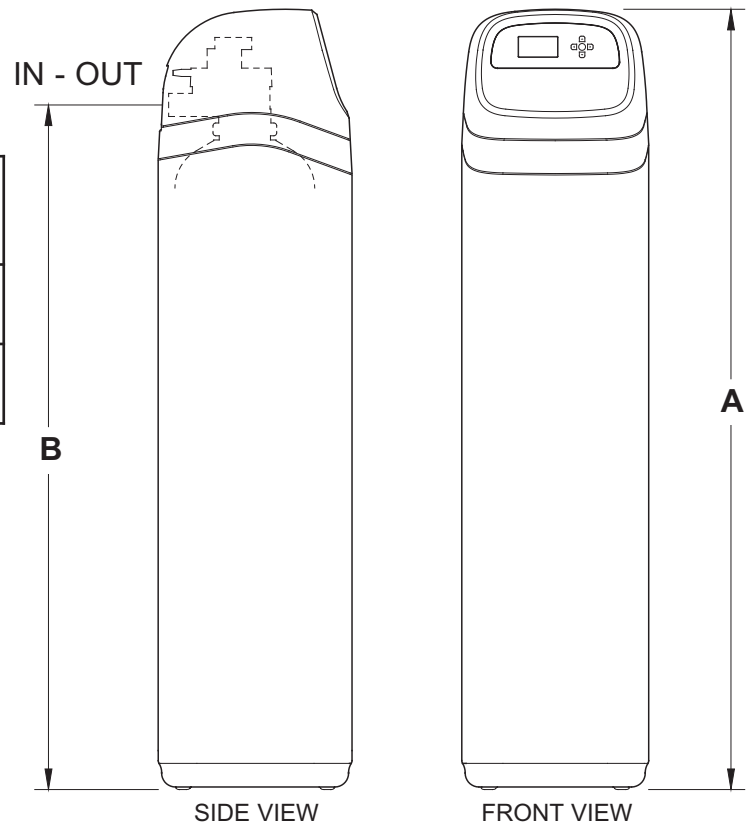

FIG. 1

UNPACKING

EcoWater Systems Air Aspirated Iron Filters are shipped from the factory in one master carton. The carton also includes a bag of small parts needed to assemble and install the unit, plus this manual.

NOTE: Filtering mineral is not included with models ETF2300EIV10 & EIV2300EIV12.

Thoroughly check the filter for possible shipping damage and parts loss. Also inspect and note any damage to the shipping carton. Notify the transportation company if damage is present. EcoWater Systems is not responsible for in-transit damages.

Remove and discard (RECYCLE) all packing materials. We suggest you keep the small parts in the bag(s) until you are ready to use them.

WHERE TO INSTALL THE FILTER

- Place the filter as close as possible to the pressure tank (well system) or water meter (city water).
- Place the filter as close as possible to a floor drain, or other acceptable drain point (laundry tub, sump, standpipe, etc.). **CAUTION:** Drain water exits the hose at a fast flow rate, and at water system pressure. Be sure the hose is fastened in some manner to prevent "whipping" and splashing to prevent water damage to surrounding area.
- Connect the filter to the main water supply pipe **UPSTREAM OF** the water heater. **DO NOT RUN HOT WATER THROUGH THE FILTER.** The temperature of water passing through the filter must be less than 120°F.
- Keep outside faucets on unfiltered water to conserve filtering capacity.
- Do not install the filter in a place where it could freeze. Damage caused by freezing is not covered by the warranty.
- Put the filter in a place water damage is least likely to occur if a leak develops. The manufacturer will not repair or pay for water damage.
- A 120V, 60 Hz electrical outlet, to plug the included power supply into, is needed near the filter. Be sure the electrical outlet and power supply are in an inside location, to protect from wet weather.

- If installing in an outside location, you must take the steps necessary to assure the filter, installation plumbing, wiring, etc., are as well protected from the elements, contamination, vandalism, etc., as when installed indoors.
- A drain is needed for recharge discharge water. A floor drain is preferred, close to the filter. A laundry tub, standpipe, etc., are other options. Be sure to provide a 1-1/2" minimum air gap, to prevent possible sewer water backup.

TOOLS, PIPE & FITTINGS, OTHER MATERIALS YOU WILL NEED

- Plastic inlet and outlet fittings included with the filter allow water flow equivalent to 1 inch nominal pipe. To maintain full valve flow, 1" pipes to and from the filter fittings are recommended. Do not reduce the pipes to less than 3/4" size.
- Use copper, brass or PEX plastic pipe and fittings.
- **ALWAYS** install the included bypass valve, or 3 shut-off valves. Bypass valves let you turn off water to the filter for repairs if needed, but still have water available to the house pipes.
- Drain hose 5/8" inside diameter minimum, with a garden hose connection on one end, is needed for the valve drain. See step 5 on page 8.
- If a rigid valve drain is needed, to comply with plumbing codes, you can buy the parts needed (see page 6) to connect a 5/8" minimum copper tubing drain.

PLAN HOW YOU WILL INSTALL THE FILTER

You must first decide how to run in and out pipes to the filter. Look at the house main water pipe at the point where you will connect the filter. Is the pipe soldered copper, glued plastic, or threaded brass/galvanized? What is the pipe size?

Now look at the typical installation illustration on page 6. Use it as a guide when planning your particular installation. Be sure to direct incoming, unfiltered water to the filter valve inlet fitting. The valve ports are marked IN and OUT.

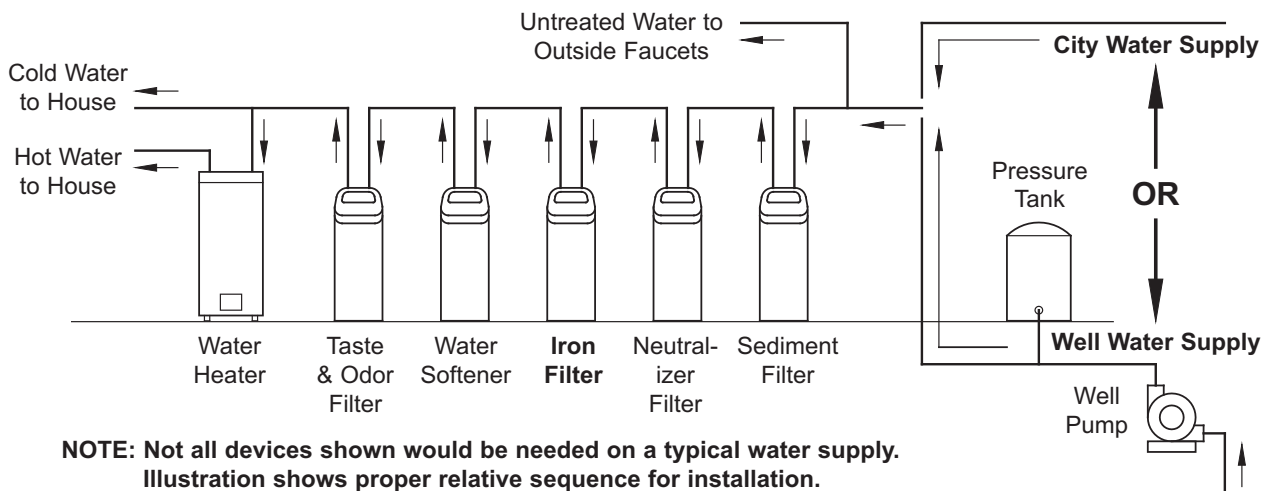
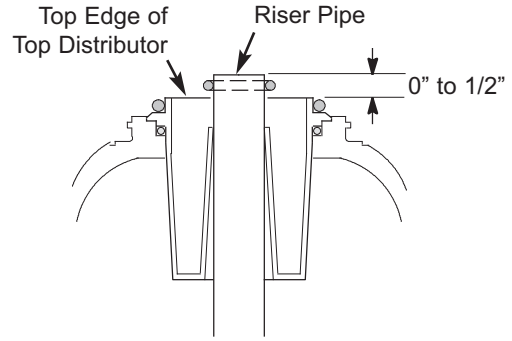

FIG. 2

MEDIA LOADING

Models ETF2300EIV10 & ETF2300EIV12, as manufactured, have no media other than quartz gravel at the bottom of the tank (See table on Page 3 for amounts). Before plumbing these units, load media:

1. Move the filter into installation location and set it on a flat, level surface. If a twin installation, keep tanks separated for ease of service.
 2. Take off the unit's top cover and unplug the wiring connections between the valve and the control board (PWA).
 3. Remove retainer clips and clamp sections from the tank neck and carefully lift the valve off the tank.
 4. Check the height of the riser pipe as shown in Figure 3. If riser pipe is more than 1/2" above the top distributor, make sure that bottom distributor is below gravel at the bottom of the tank. It may be necessary to lay the filter on its side to move gravel to one side, hold the bottom distributor at the bottom center of the tank and stand the unit back up. Level gravel after checking.
 5. After confirming the riser pipe height, remove the top distributor from the tank neck, leaving the bottom distributor (including riser pipe) in place, centered in the tank.
 6. Cover the top end of the riser pipe with a clean rag, to keep media out (See Fig. 4).
 7. Using a larger neck funnel, add the necessary amount of media.
 8. Flush the tank opening with water to clean media particles from the top of the tank. Uncover the bottom distributor stand tube.
 9. Fill the tank with water, up to the top of the tank.
- IMPORTANT:** Be sure to fill with water. This will eliminate air space, wet the media and prevent excessive air-head pressure when filter is pressurized.
10. Install the o-ring seals and top distributor exactly as shown in Figure 5. Place the small o-ring at the top of the riser pipe, where shown in Figure 3. If the o-rings need lubrication, use a high quality silicone grease.
 11. Lower the valve assembly onto the tank, centering over the riser tube. Push downward, against the o-ring, and install the clamp sections, securing with the retainer clips.
 12. Reconnect the wiring between the valve and the control board (PWA).
 13. Verify that the drain flow plug (See Key No. 59 on Page 35) is appropriately sized for the media used. If necessary, install a different flow plug.



Note: Resin tank height can vary somewhat within manufacturing tolerance. So that the bottom distributor riser pipe has proper clearance with inside valve porting, check for the correct length, as shown above. Cut the riser pipe if needed to adjust the length. Be sure to remove burrs and sharp edges.

FIG. 3

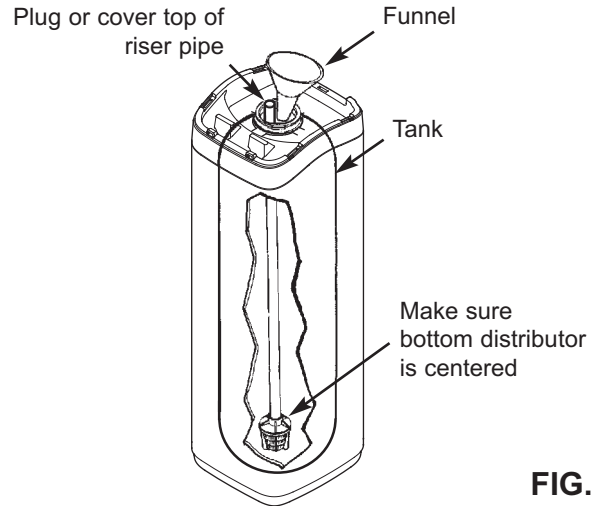

FIG. 4

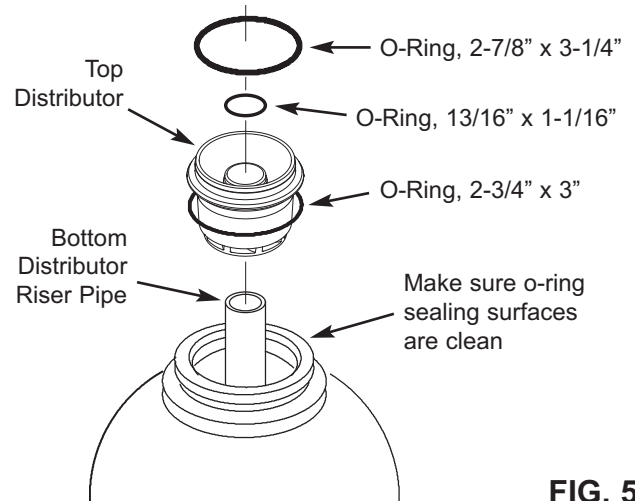

FIG. 5

INSTALLATION USING ECOWATER BYPASS VALVE

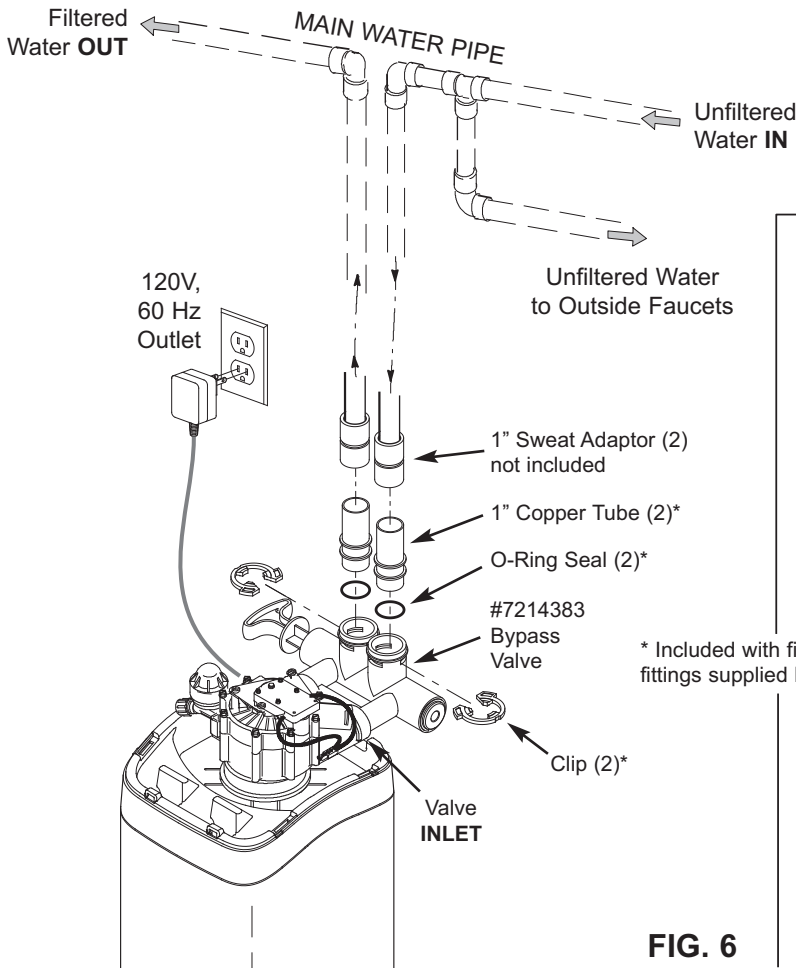
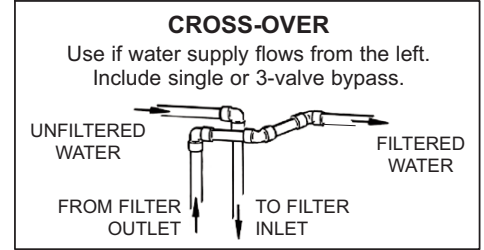

FIG. 6



INSTALLATION USING 3-VALVE BYPASS

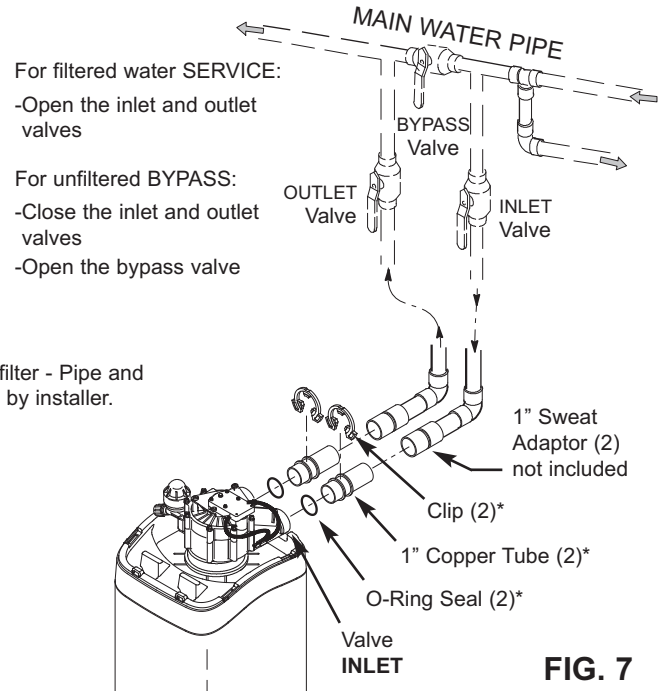

FIG. 7

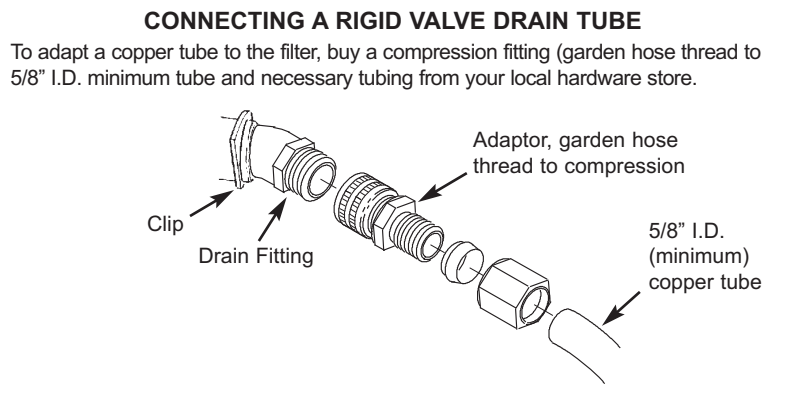
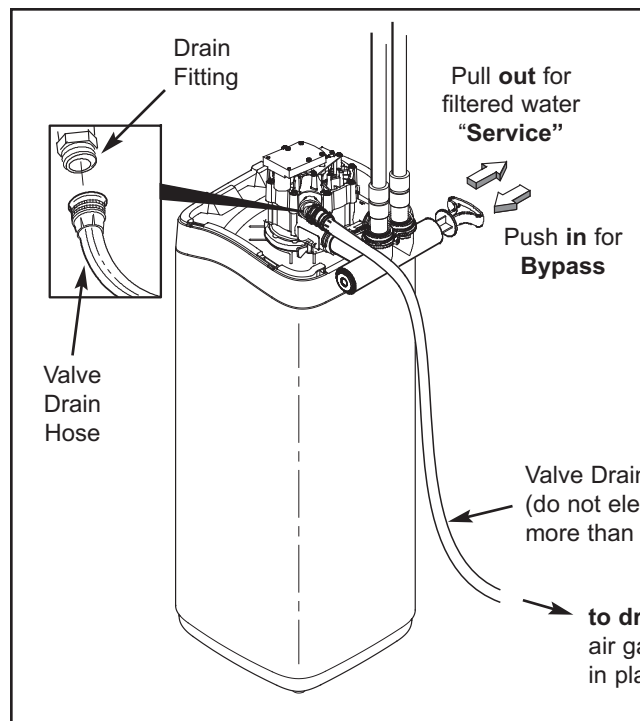

FIG. 8

1. TURN OFF WATER SUPPLY

- a. Close the main water supply valve near the well pump or water meter.
- b. Shut off the electric or fuel supply to the water heater.
- c. Open high and low faucets to drain all water from the house pipes.

2. INSTALL BYPASS VALVE AND/OR PLASTIC ADAPTOR / COPPER TUBE:

- a. If installing a single bypass valve, push the bypass valve, with lubricated o-ring seals in place, into the valve inlet and outlet ports (See Figures 6 & 9).
- OR -
- b. If installing a 3-valve bypass system, slide plastic installation adaptor and copper tube, with lubricated o-ring seals in place, into the valve inlet and outlet ports, respectively (See Figures 7 & 9).
- c. Make sure that the check valve is in place in the valve inlet, with the flow arrow pointed inward, as shown in Figure 9.
- d. Make sure that the turbine and support are in place in the valve outlet, as shown in Figure 10.
- e. Snap the two large plastic clips in place on the inlet and outlet ports, from the top, down (See Figure 11). Be sure they snap into place. Pull on the bypass valve, copper tube or plastic adaptor, to make sure they are held securely in place.

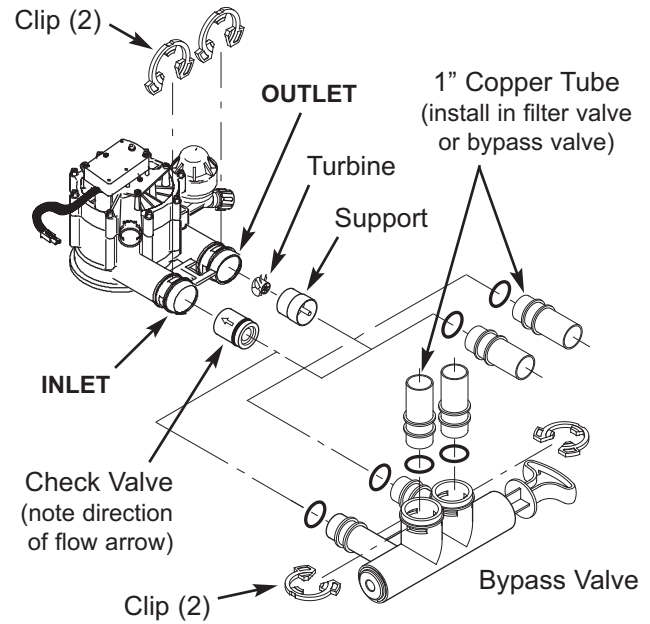

FIG. 9

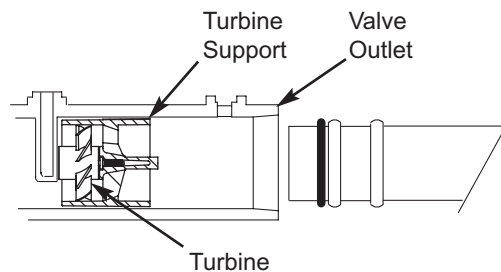

FIG. 10

3. COMPLETE PLUMBING TO AND FROM THE FILTER

Using the "Typical Installation Illustrations" on page 6 as a guide, observe all of the following cautions while you connect inlet and outlet plumbing:

- Be sure incoming, **unfiltered water** is directed to the valve **INLET** port.
- Be sure to install bypass valve(s).
- If making a soldered copper installation, do all sweat soldering before connecting pipes to the filter fittings. Torch heat will damage plastic parts.
- Use pipe joint compound on all external pipe threads.
- When turning threaded pipe fittings onto plastic fittings, use care not to cross-thread.
- Support inlet and outlet plumbing in some manner (use pipe hangers) to keep the weight off of the valve fittings.

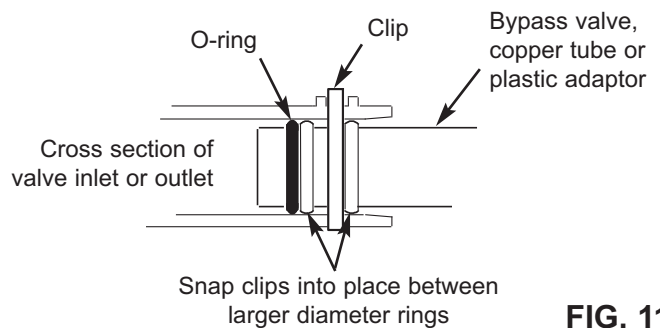
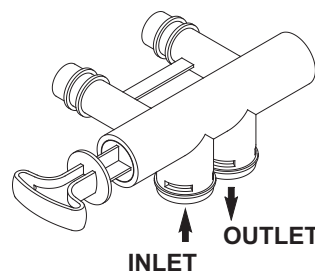

FIG. 11



Turn the bypass valve downward if connecting to floor level plumbing

FIG. 12

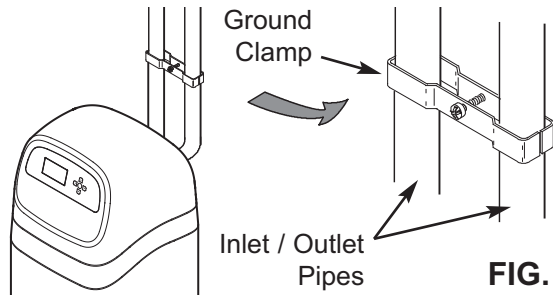

FIG. 13

4. COLD WATER PIPE GROUNDING

The house cold water pipe (metal only) is often used as a ground for the house electrical system. The 3-valve bypass type of installation, shown in Figure 7, will maintain ground continuity. If you use the plastic bypass, continuity is broken. To restore the ground, do either step **4a** or **4b** following.

- a. Use the EcoWater ground clamp kit (not included) to make a jumper across the inlet and outlet pipes (See Figure 13).
- b. Install a #4 copper wire across the removed section of main water pipe, securely clamping at both ends – parts not included.

5. INSTALL VALVE DRAIN HOSE

- a. Take a length of 5/8" inside diameter garden hose and attach to the valve drain fitting (See Figure 8 on page 6).
- b. Locate the other end of the hose at a suitable drain point (floor drain, sump, laundry tub, etc.). Check and comply with local codes. Refer to Figure 8 on page 6 if codes require a rigid pipe drain run.

IMPORTANT: Use high quality, thick wall hose that will not easily kink or collapse. The filter will not backwash properly if water cannot exit this hose during recharges.

- c. Tie or wire the hose in place at the drain point. Water pressure will cause it to whip during the backwash portion of the recharge cycle. Also provide an air gap of at least 1-1/2" between the end of the hose and the drain point. An air gap prevents possible siphoning of sewer water, into the filter, if the sewer should back up.
- d. If raising the drain hose overhead is required to get to the drain point, do not raise higher than 8 feet above the floor. Elevating the hose may cause a back pressure that could reduce backwash flow and proper mineral bed cleaning.

6. FLUSH PIPES AND TEST FOR LEAKS

CAUTION: To avoid water or air pressure damage to filter inner parts, be sure to do the following steps exactly as listed:

- a. Fully open two filtered water faucets, one cold and one hot, nearby the filter.

- b. Place bypass valve(s) into "bypass" position. On a single valve, slide the stem inward to BYPASS (See Fig. 8 on page 6). On a 3 valve system, close the inlet and outlet valves, and open the bypass valve (See Fig. 7 on page 6).
- c. Fully open the house main water pipe shutoff valve. Observe a steady flow from both opened faucets.
- d. Close both faucets.
- e. Check your plumbing work for leaks and, if any are found, fix right away. Be sure to observe previous caution notes.
- f. Turn on the gas or electric supply to the water heater. Light the pilot, if applicable.

7. CONNECT TO ELECTRICAL POWER:

The filter controller works on 24V DC electrical power. The included power supply converts 120V AC household power to 24V DC. Plug the power supply into a 120V, 60 Hz electrical outlet. Be sure the outlet is always "live" so it can not be switched off by mistake.

8. PROGRAM THE CONTROLLER

See pages 10-12 for instructions to program the electronic controller.

9. START UP PROCEDURE

- a. Confirm that the filter's main valve is in the "service" position ("S" on the cam).
- b. Place bypass valve(s) into "service", EXACTLY as follows:
 - **Single Bypass Valve:** SLOWLY, pull the valve stem outward to "service" position, pausing several times to allow the filter to pressurize slowly.
 - **3 Valve Bypass:** Fully close the bypass valve and open the outlet valve. SLOWLY, open the inlet valve, pausing several times to allow the filter to pressurize slowly.
- c. Check all connections for leaks.
- d. **Start a recharge:** From the rolling status screens, press the SELECT (O) button to display the **Main menu**. Make sure **Recharge** is highlighted, then press SELECT (O). Press DOWN (▼) to scroll to **Recharge now**, then press SELECT (O) twice. You should hear the valve motor run as the filter begins recharging. Verify that the valve advances to "backwash" (BW) position.
- e. Allow the unit to remain in "backwash" (BW) while air is purged and water exits the drain line. Ensure that the drain line is secure and will withstand the mix of air and water exiting.
- f. Allow the unit to complete the 15 minute "backwash" cycle and automatically advance to the "aspirate" (A) position. Allow it to remain there as it aspirates air into the mineral tank. After 75 minutes, the filter will then automatically return to "service". Start up is complete.

Service water enters the filter and passes through air captured at the top of the mineral tank. Dissolved iron is oxidized and then removed by the media in the tank. When the system recharges, it first backwashes the contaminants to the drain, then empties the

tank of water, replacing it with air drawn through the aspirator. When the system returns to "service", the water pressure will compress the air in the mineral tank and leave an 8-14" head of air on the top of the tank.

Care is taken at the factory to keep your water filter clean and sanitary. Materials used to make the filter will not infect or contaminate your water supply, and will not cause bacteria to form or grow. However, during shipping, storage, installing and operating, bacteria could get into the filter or media. For this reason, sanitizing as follows is suggested* when installing.

1. Obtain pharmaceutical grade 12% hydrogen peroxide solution. One quart (0.95 L) is required for a 10" filter, 2 quarts (1.9 L) for a 12" filter.
2. Remove air inlet screen from check valve on the valve's nozzle & venturi assembly (See Figure 14).
3. Connect a length of 3/8 I.D. tubing to the barb on the aspirator check valve (See Figure 15).
4. Insert the free end of the tubing into the hydrogen peroxide container.
5. **Start a recharge:** From the rolling status screens, press the SELECT (○) button to display the **Main menu**. Make sure **Recharge** is highlighted, then press SELECT (○). Press DOWN (▼) to scroll to **Recharge now**, then press SELECT (○) twice. You should hear the valve motor run as the filter begins recharging. The filter will backwash for 15-17 minutes, then advance automatically to the "aspirate" position. It will draw the hydrogen peroxide into the filter and pass it through the zeolite media, cleaning and sanitizing the media.
6. Allow the filter to draw air for the remainder of the time in the "aspirate" cycle after the hydrogen peroxide has been drawn into the filter.
7. The filter will return to "service" automatically when the "aspirate" cycle is complete.
8. Remove tubing and reinstall the aspirator inlet screen onto the barbed fitting on aspirator check valve.
9. Cleaning/sanitizing process is complete.

***NOTE:** Sanitizing is recommended by the Water Quality Association for disinfecting. On some water supplies, they suggest periodic sanitizing.

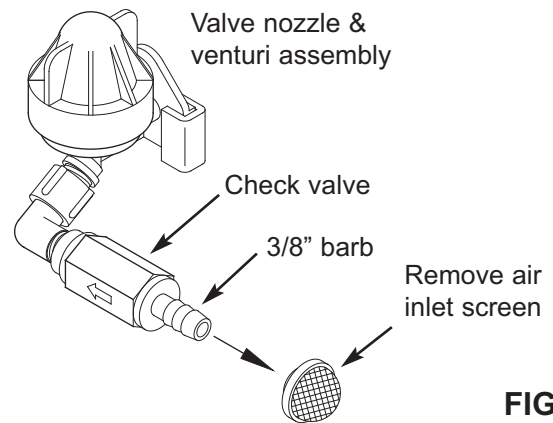

FIG. 14

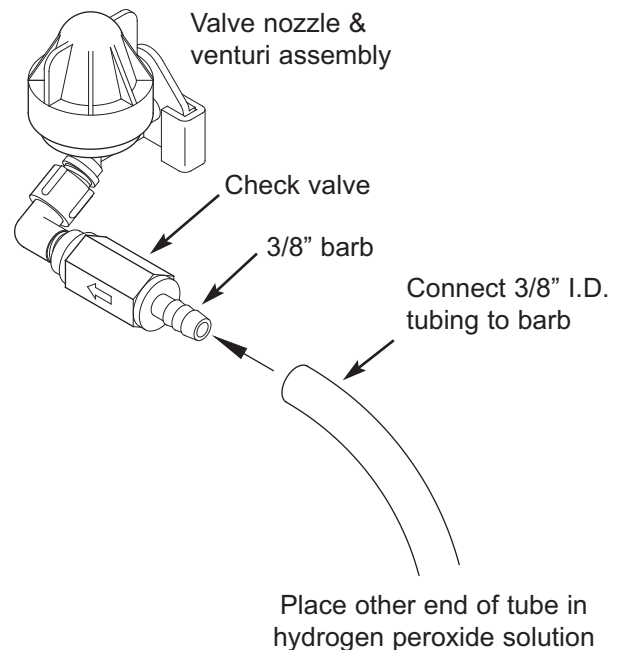
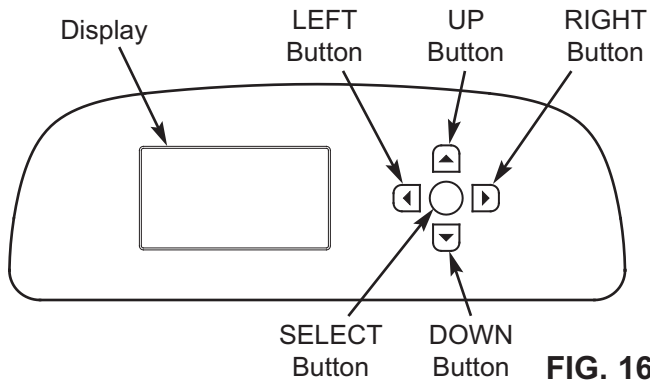

FIG. 15



Pushbutton (WPS) Option

- Use the SELECT (○) button to choose **Pushbutton (WPS)**. The filter display will change to show “Push wireless router button”.

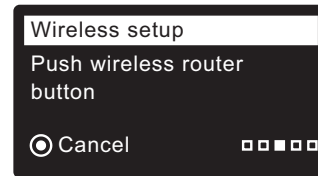

FIG. 19

- Press the WPS or Push to Connect button on your router and wait for a minute or two to see if the display changes again to “Connected” and gives you a key code. If not, you may need to cancel and use the browser option.

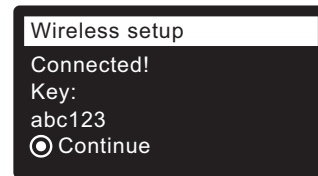

FIG. 20

- Once the key code is displayed, write it down. It will be used when you register your system on the EcoWater web site. Proceed to Step 16 on the next page.

NOTE: If the “Connected” message shows “-----” (dashes) instead of a key code, it may be that your router is not connected to the internet. Verify that the router’s internet connection works with your laptop or other device.

Browser Option

- Press the filter’s DOWN (▼) button to scroll to **Browser**.

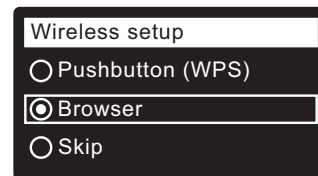

FIG. 21

- Press the SELECT (○) button twice. The filter display will change to show “See connection instructions”.

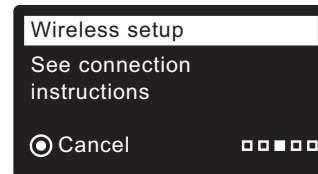

FIG. 22

continued on the next page

SETUP PROCEDURE

When the EcoWater Systems filter is plugged in for the first time, a beep sounds and the display briefly shows a logo, followed by model information. Next, a series of “wizard” screens prompts you to enter basic operating information:

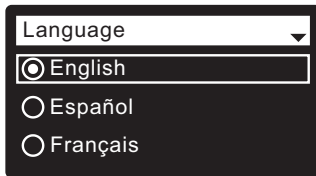

FIG. 17

- LANGUAGE** If the desired language already has a dot next to it (See Figure 17), go to Step 2. Otherwise, press the filter’s DOWN (▼) or UP (▲) buttons to scroll to the desired language, then press the SELECT (○) button to choose it.
- Press the SELECT (○) button to advance to the next “wizard” screen.

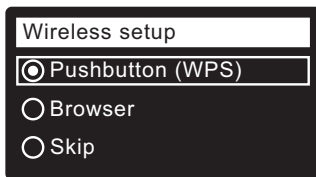

FIG. 18

NOTE: Wireless Setup can also be done after the rest of the Setup Procedure (Steps 16-24) has been completed. From the **Main menu**, go down to the **Advanced settings** menu and select **Wireless setup**.

- WIRELESS SETUP** Choose how you will connect the filter to your home’s wireless network:

Browser: You can connect using the browser on your laptop, tablet or phone. Skip to Step 7.

OR

Pushbutton: If your wireless router has a **WPS** (Wi-Fi Protected Setup) or **Push to Connect** button, you can use this method to connect. Proceed to Step 4.

continued from the previous page

- On your laptop, tablet or phone, activate the view of wireless networks in range. For example, on a laptop, look for and click on the wireless icon along the lower right edge of the screen. On a phone, you should go into "Settings" and look for "Wi-Fi".



FIG. 23

- You should see a network named "H2O-" followed by 12 characters. Select this network to connect your device with it.

- Once your device indicates that it is connected to the H2O network, go to your internet browser (Chrome, Firefox, Internet Explorer, etc.) and type in this URL:

192.168.0.1

then click Go or press Enter.

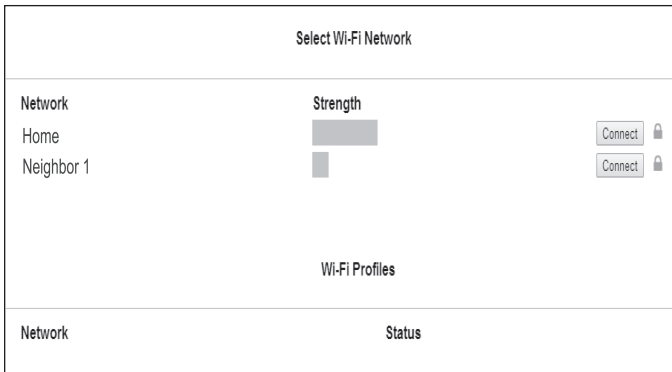

FIG. 24

- After a screen like the one shown above appears, select your in-home wireless network and enter the correct password.
- The filter display should change to "Connected" and give you a key code.

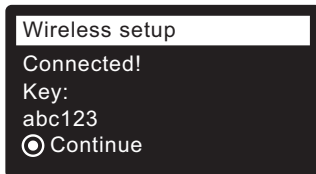

FIG. 25

- Once the key code is displayed (it may take a few seconds), write it down. It will be used when you register your system on the EcoWater web site.

NOTE: If the "Connected" message shows "-----" (dashes) instead of a key code, it may be that your router is not connected to the internet. Verify that the router's internet connection works with your laptop or other device.

- On your laptop, tablet or phone, go back to the view of networks in range, and make sure that your device is connected back to your local network.

Finish Setting up the Filter

- Once you have connected the Wi-Fi system and written down your key code, press the SELECT (O) button to advance to the next "wizard" screen.

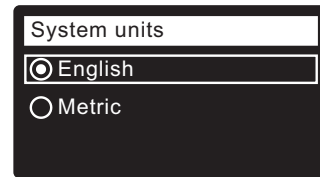

FIG. 26

- SYSTEM UNITS** If the desired system already has a dot next to it (See Figure 26), go to Step 18. Otherwise, press the DOWN (▼) or UP (▲) buttons to scroll to the desired system, then press the SELECT (O) button to choose it.

- Press the SELECT (O) button.

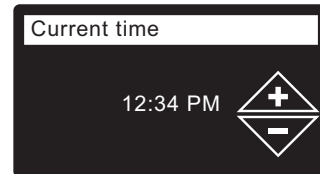

FIG. 27

- CURRENT TIME** Press the DOWN (▼) or UP (▲) buttons to set the current time (See Figure 27). Hold the button down to rapidly advance. Be sure that AM or PM is correct. If the system units were set to metric in Step 17, the clock will be in 24-hour format.

- Press the SELECT (O) button.

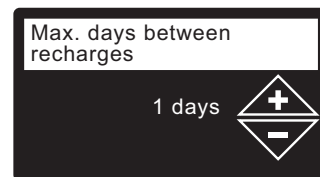

FIG. 28

- MAX. DAYS BETWEEN RECHARGES** Press the UP (▲) or DOWN (▼) buttons to set the number of days between automatic recharges (See Figure 28) The feature can be set from 1 to 99 days.

continued on the next page

continued from the previous page

	No. of People	Iron (parts per million)			
		1 - 2	3 - 5	6 - 10	11 - 20
Model ETF2300- AIV10	1 - 2	3 days	2 days	1 day	use AIV12
	3 - 4	2 days	2 days	1 day	use AIV12
	5 - 7	1 day	1 day	use AIV12	use AIV12
Model ETF2300- AIV12	1 - 2	4 days	3 days	2 days	1 day
	3 - 4	3 days	2 days	1 day	1 day
	5 - 7	2 days	1 day	1 day	1 day

Use the table above to determine the number of days between recharges, based on the number of people in the household and the iron ppm (parts per million) in the water supply.

NOTE: If the water supply has high turbidity (sand, silt, sediments, etc.) set to recharge more often than the table shows.

22. Press the SELECT (O) button. The screen will show "Setup complete!" (See Figure 29).

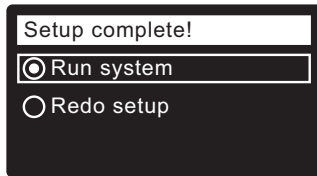

FIG. 29

23. If, at this point, you want to go back and make changes, press the DOWN (▼) button to scroll to **Redo setup**, then press the SELECT (O) button twice to repeat the "wizard" screens.

24. If no changes are desired, make sure **Run system** has a dot next to it (See Figure 29) and press the SELECT (O) button. The unit begins normal operation, described on Page 14.

HOW TO REGISTER A SYSTEM ON THE ECOWATER WEB SITE AS A DEALER

NOTE: A dealer registering filters must log in as a dealer, not as a customer.

25. In your internet browser, type in this URL:

http://wifi.ecowater.com

26. If you are a dealer, and have an account, log in to your account and go to the next step. If you are a customer, go to Page 13 for instructions to create an account and register.

27. After you've logged in to your dealer account, click "Add New Customer System" and then enter the key code that you wrote down earlier. If you wait

too long between writing down the key code and registering (an hour or less), the code may change. This is a security feature. Look up the new key code, as described in the following note.

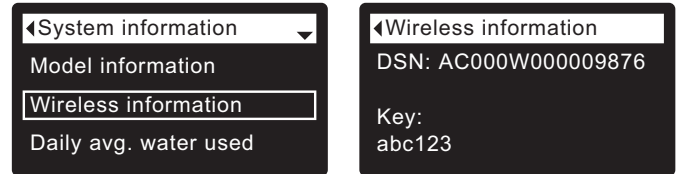

FIG. 30

NOTE: You can look up the current key code on your filter's controller. From the **Main menu**, go down to the **System information** menu and select **Wireless information**.

28. After you've entered the key code in the **Add System** screen, click the "Connect" button to advance to the **Customer Information** screen.
29. Fill in the customer information (address, e-mail, etc.). When entering a password, either have the customer enter their own, or enter one for them and give it to them. If you intend to share the system, sharing needs to be done from the customer's account (See "How to Share a System" on the following page). When finished filling in the customer information screen, click the "Save and Continue" button.

NOTE: When filling in address information, be sure to select the country before attempting to select a state or province.

30. Fill in the **System Settings** screen and click the "Save Settings" button.
31. Fill in the **Dealer Communication Preferences** screen and click the "Save and Continue" button.
32. The message "Customer System Setup Complete" should appear, along with the customer's account screen. At this point you can make changes or add another system for this customer. When everything is correct, return to the dealer Home page by clicking the "Home" tab along the top of the page.
33. On the dealer Home page, the new system you set up should appear on the systems list.

NOTE: On the dealer Home page, the number of shared systems is displayed below the bar along the top of the screen. You can display only shared systems by clicking "shared with you", and display all systems again by clicking the "Home" tab. See the following page for instructions on how to share a system.

HOW TO CREATE AN ACCOUNT AND REGISTER YOUR SYSTEM ON THE ECOWATER WEB SITE AS A CUSTOMER

NOTE: A dealer registering filters must log in as a dealer, not as a customer.

1. In your internet browser, type in this URL:
http://wifi.ecowater.com
 2. If you are a new customer, click on “Create Account” to advance to the **Create Your Account** screen.
 3. Fill in the account information (e-mail, password, language, etc.). Agree to the Terms of Use, and then click the “Create Account” button to advance to the **Customer Information** screen.
 4. Fill in the customer information (name, address, etc.). When finished filling in the customer information screen, click the “Save and Continue” button.
- NOTE:** When filling in address information, be sure to select the country before attempting to select a state or province.
5. Follow the instructions on the **Verify e-mail** screen. You will shortly receive an e-mail confirming that you have created your account. Open this e-mail and click on the link it contains. Your browser will be directed to a **Verification Complete** screen.
 6. Now that you have created your account, you may log in. In the verification screen, click the “logging in” link (or go to **http://wifi.ecowater.com**).
 7. Log in with the e-mail and password that you entered when creating your account.
 8. After you’ve created and logged in to your account, the **Add System** screen will appear. Enter the key code that you wrote down earlier. If you wait too long between writing down the key code and registering (an hour or less), the code may change. This is a security feature. Look up the new key code, as described in the following note.

9. After you’ve entered the key code in the **Add System** screen, click the “Connect” button to advance to the **System Settings** screen.
10. Fill in the **System Settings** screen and click the “Save Settings” button.
11. Fill in the **Communication Preferences** screen and click the “Save and Continue” button.
12. The screen should change to show the Home page for your system, including the filter “dashboard”. Click the “Log Out” tab when you are done.

VISITING YOUR CUSTOMER ACCOUNT

Any time after your customer account has been created and system registered, you can visit your account to see your filter “dashboard”, change settings, etc. Direct your browser to **http://wifi.ecowater.com** and log in using the e-mail and password that were specified when setting up the account.

HOW TO SHARE A SYSTEM BETWEEN A DEALER AND CUSTOMER

NOTE: A system can only be shared from a customer’s account, not a dealer’s.

Systems can be “shared” between a dealer and customer. If a system is shared, the dealer has full access to the displays and settings for that system on the EcoWater Wi-Fi web site. If a system is not shared, the dealer only has access to the “Dealer Communication Preferences” screen for that system.

Once a customer account has been created by a dealer, a customer can grant a dealer access to their system. Access can only be granted to the dealer who sold that system.

With permission, a dealer (but only the one who sold the system) could also grant it for the customer. To do so, a dealer must log in as a customer rather than as a dealer, using the customer’s e-mail and password (which were entered when the customer account was created).

1. Go to **http://wifi.ecowater.com** and log in (customer’s e-mail and password, not dealer’s).
2. Click on the “Support” tab along the top of the customer Home page.
3. On the **Support** screen, click the “Grant Access” button. It should change to read “Revoke Access”.
4. The system is now shared. Click the “Log Out” tab when you are done.

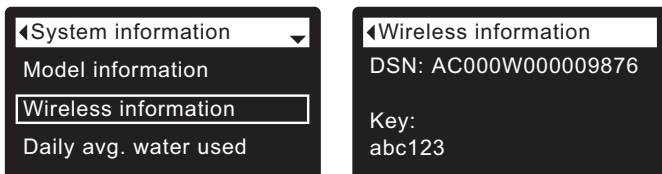

FIG. 31

NOTE: You can look up the current key code on your filter’s controller. From the **Main menu**, go down to the **System information** menu and select **Wireless information**.

NORMAL OPERATION

FILTER STATUS SCREENS

During normal operation, the EcoWater Systems filter’s display shows up to four status screens. Page 19 explains how individual screens can be turned on or off. Each is shown for six seconds, in a rolling sequence (See Figure 32).

On the “Wireless status” screen, the check marks indicate the following:

- ✓ **WiFi** - The filter is connected to a Wi-Fi router.
- ✓ **Internet** - The filter is connected to a Wi-Fi router which is connected to the internet.

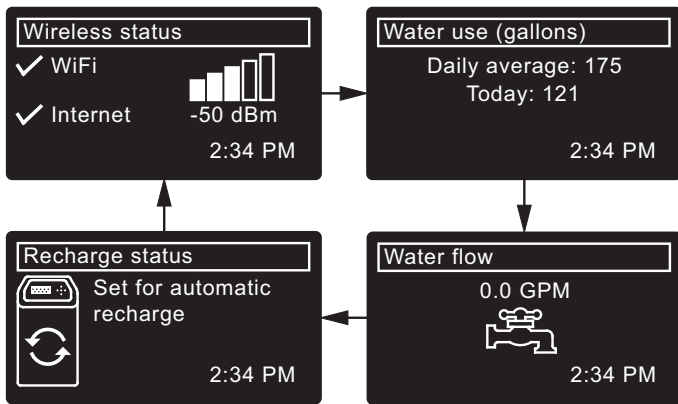

FIG. 32

Pressing the filter’s RIGHT (▶) button manually advances to the next screen in the sequence. Pressing the LEFT (◀) button manually returns to the previous status screen. If no buttons are pressed for 30 seconds, the automatic rolling sequence resumes.

If **Recharge off** has been selected, as described on page 17, the rolling sequence will stop at the “Recharge status” screen.

OTHER MESSAGES, ALERTS & REMINDERS

The filter status screens described in the previous section will not be displayed in a rolling sequence when one of the following items is displayed:

- **Recharge status** (Displayed during recharges, showing valve position and time remaining)
- **Recharge status: Off - no automatic recharges** instead of rolling screens indicates that automatic recharges have been turned off (See Page 17).
- **Current time** setting screen instead of status screens indicates time has been lost, perhaps after a long power loss. Set the time (See next page).
- **Service reminder** (See Page 23)
- **Error detected** (Contact your dealer for service)

FLASHING DISPLAY

The filter’s display will flash on and off when one or more of the following conditions occurs:

- Time needs to be set (Time has been lost)
- Service is overdue (Service reminder)
- Error condition

The flashing will stop after any key is pressed. However, it will start again at Midnight if the underlying condition (e.g. time not set) has not been addressed.

LONG DISPLAY SCREEN MESSAGES

Most messages in the filter’s display screens are short enough to be shown as a single line. Longer messages will be truncated (See Figure 33 for an example) until you highlight them.

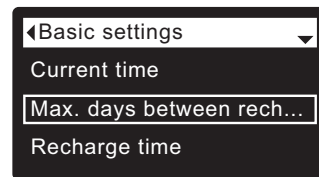

FIG. 33

One second after being highlighted, the viewing box expands (See Figure 34) to show the entire message. After three seconds the view resets (Figure 33).

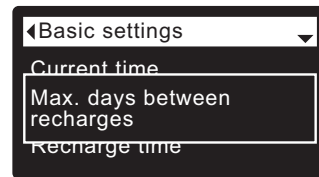

FIG. 34

MAIN MENU

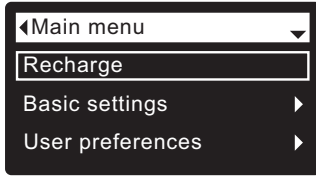

FIG. 35

During normal operation (status screens rolling), press the filter’s SELECT (O) button to display the Main menu (See Figure 35). This menu and its subsidiary screens are used to control these operations:

- **Recharge** (See Page 17)
- **Basic settings**
 - **Current time** (See next column)
 - **Max. days between recharges** (See Page 18)
 - **Recharge time** (See Page 19)
 - **Rolling screens** (See Page 19)
- **User preferences**
 - **Language** (See Page 20)
 - **Time format** (See Page 20)
 - **Volume units** (See Page 20)
- **System information**
 - **Model information** (See Page 21)
 - **Wireless information** (See Page 21)
 - **Daily avg. water used** (See Page 21)
 - **Water used today** (See Page 21)
 - **Total water used** (See Page 21)
 - **Current water flow** (See Page 21)
 - **Days powered up** (See Page 21)
 - **Last recharge** (See Page 21)
 - **Total recharges** (See Page 21)
- **Advanced settings**
 - **Cycle times**
 - **Backwash time** (See Page 22)
 - **Fast rinse time** (See Page 22)
 - **Special features**
 - **Auxiliary control** (See Page 24)
 - **Chemical feed volume**** (See Page 24)
 - **Chemical feed timer**** (See Page 24)
 - **Service reminder** (See Page 23)
 - **Troubleshooting**
 - **Diagnostics** (See Page 25)
 - **Setup changes** (See Page 25)
 - **Wireless setup** (See Pages 10-11)

**Only displayed if Auxiliary control is set to Chemical feed.

SETTING THE CURRENT TIME

When the filter’s electronic control is first powered up, a “wizard” screen prompts you to set the current time (See Page 11). To change the time at a later date, such as after a long power loss:

1. From any of the rolling status screens, press the SELECT (O) button to display the **Main menu**.
2. Press the DOWN (▼) button to scroll through the menu options until **Basic settings** is highlighted (See Figure 36).

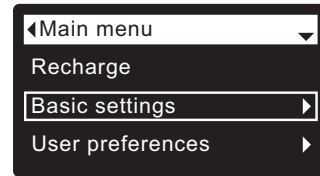

FIG. 36

3. Press the SELECT (O) button to display the Basic settings menu (See Figure 37).

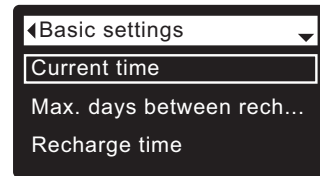

FIG. 37

4. Make sure **Current time** is highlighted.
5. Press the SELECT (O) button to display the Current time screen (See Figure 38).

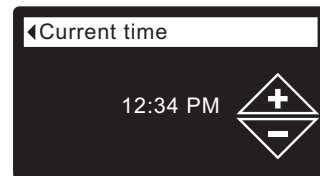

FIG. 38

6. Press the UP (▲) or DOWN (▼) buttons to change the time. Hold the button down to rapidly advance. Be sure that AM or PM is correct (unless filter is set for a 24-hour clock).
7. Press the SELECT (O) button. The display will go back to the Basic settings menu (Figure 37).
8. Press the LEFT (◀) button twice to return to the rolling status screens.

NOTE: On Wi-Fi connected systems, the current time will be updated and maintained automatically via Wi-Fi.

LOCKOUT FEATURE

A “lockout” feature is available to prevent user modification of parameters that affect filter performance. The unit is shipped from the factory with the lockout feature off. After programming is complete, the lockout feature can be turned on to prevent changes to the following:

- **Max days between recharges**
- **Backwash time**
- **Fast rinse time**
- **Auxiliary control**
- **Chemical feed volume**
- **Chemical feed timer**
- **Service reminder**
- **Setup changes**

To turn on the lockout feature:

1. From any of the rolling status screens, press the SELECT (O) button to display the **Main menu**.
2. Press the DOWN (▼) button to scroll through the menu options until **Advanced settings** is highlighted.
3. Press the SELECT (O) button to display the Advanced settings menu.
4. Press the DOWN (▼) button to scroll through the menu options until **Troubleshooting** is highlighted.
5. Press the SELECT (O) button to display the Troubleshooting menu.
6. Press the DOWN (▼) button to scroll through the menu options until **Setup changes** is highlighted.
7. Press the SELECT (O) button to display the Setup changes menu (See Figure 39).

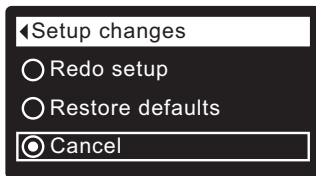

FIG. 39

8. Press the RIGHT (▶) button. A flashing padlock icon will appear, as shown in Figure 40.

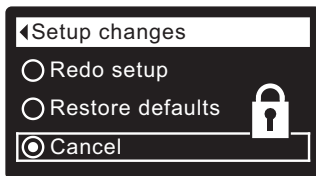

FIG. 40

9. Press the SELECT (O) button.
10. Press the LEFT (◀) button three times to return to the rolling status screens.

When the lockout feature is on, the flashing padlock icon will appear in any screen that would normally be used to change a parameter in the list to the left. For example, the **Max. days between recharges** screen will look like Figure 42, instead of Figure 41.



FIG. 41

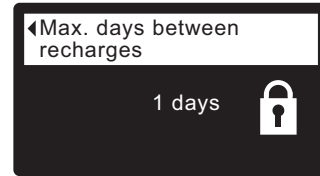

FIG. 42

Another indicator that the lockout feature is on is the **Model Information** screen. This screen appears on power-up, and can also be displayed from the System Information menu (See Page 21). If the lockout feature is on, there will be a non-flashing padlock icon in the upper right corner (See Figure 43).

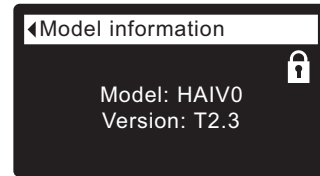

FIG. 43

To turn off the lockout feature:

- 1-7. Go to the **Setup changes** screen (Figure 40) by following Steps 1-7 at left.
8. Press the RIGHT (▶) button. The flashing padlock icon will disappear, as shown in Figure 39.
9. Press the SELECT (O) button.
10. Press the LEFT (◀) button three times to return to the rolling status screens.

RECHARGING THE FILTER

This feature may be used to assure an adequate supply of conditioned water at times of unusually high water use. For example, if you have guests you could deplete conditioned water capacity before the next automatic recharge. Initiating a manual recharge will restore 100% conditioned water capacity after complete.

1. From any of the rolling status screens, press the SELECT (O) button to display the **Main menu**.

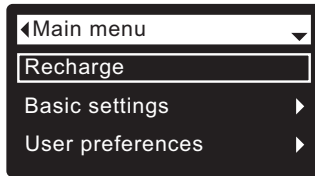

FIG. 44

2. Make sure **Recharge** is highlighted (See Figure 44).
3. Press the SELECT (O) button to display the Recharge menu (See Figure 45).

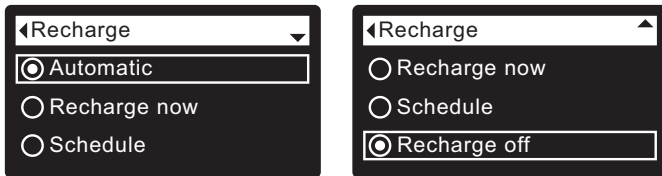

FIG. 45

4. If the desired option already has a dot next to it (See Figure 45), go to Step 5. Otherwise, press the DOWN (▼) or UP (▲) buttons to scroll to the desired option, then press SELECT (O) to choose it.

- **Automatic** cancels a manually scheduled recharge (if it has not already begun) and lets the electronic control determine when to recharge next.

- **Recharge now** begins a recharge immediately after the SELECT (O) button is pushed again in Step 5.

- **Schedule** sets a recharge to begin at the preset recharge time (set according to the instructions on Page 19).

- **Recharge off** puts the system into a “vacation mode” where there will be no automatic recharges. This can be used during any long absence when you do not want the system using water. The recharge status screen will display “No automatic recharges”. When you return, be sure to cancel **Recharge off** by setting recharge to **Automatic** or **Schedule**. Initiating **Recharge now** does not cancel **Recharge off**.

5. Press the SELECT (O) button. If **Recharge now** is selected, the display immediately goes to the Recharge status screen (See Figure 46). If **Automatic**, **Schedule**, or **Recharge off** are selected, the display goes back to the Main menu (Figure 44).

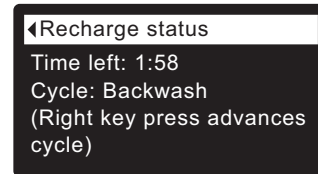

FIG. 46

6. Press the LEFT (◀) button (twice from the Recharge status screen) to return to the rolling status screens. If **Recharge off** was selected, the normal sequence of rolling screens will stop at the screen shown in Figure 47.

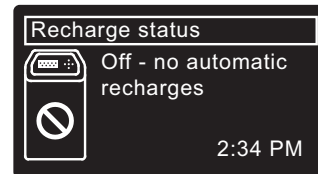

FIG. 47

SETTING MAXIMUM DAYS BETWEEN RECHARGES

When the filter's electronic control is first powered up, a "wizard" screen prompts you to set the number of days between automatic recharges (See Page 11). To change it:

1. From any of the rolling status screens, press the SELECT (O) button to display the **Main menu**.
2. Press the DOWN (▼) button to scroll through the menu options until **Basic settings** is highlighted (See Figure 48).

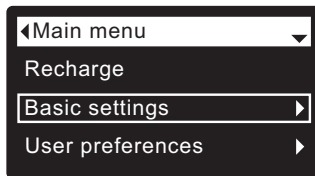

FIG. 48

3. Press the SELECT (O) button to display the Basic settings menu (See Figure 49).

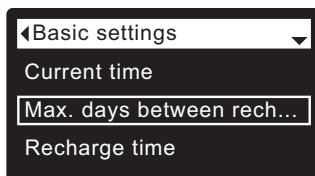

FIG. 49

4. Press the DOWN (▼) button to scroll through the menu options until **Max. days between rech...** is highlighted.
5. Press the SELECT (O) button to display the Max. days between recharges screen (See Figure 50).

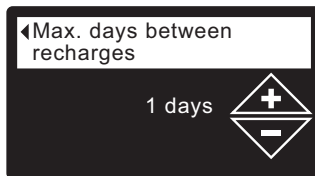

FIG. 50

6. Press the UP (▲) or DOWN (▼) buttons to change the number of days between automatic recharges. The feature can be set from 1 to 99 days.

	No. of People	Iron (parts per million)			
		1 - 2	3 - 5	6 - 10	11 - 20
Model ETF2300- AIV10	1 - 2	3 days	2 days	1 day	use AIV12
	3 - 4	2 days	2 days	1 day	use AIV12
	5 - 7	1 day	1 day	use AIV12	use AIV12
Model ETF2300- AIV12	1 - 2	4 days	3 days	2 days	1 day
	3 - 4	3 days	2 days	1 day	1 day
	5 - 7	2 days	1 day	1 day	1 day

Use the table above to determine the number of days between recharges, based on the number of people in the household and the iron ppm (parts per million) in the water supply.

NOTE: If the water supply has high turbidity (sand, silt, sediments, etc.) set to recharge more often than the table shows.

7. Press the SELECT (O) button. The display will go back to the Basic settings menu (Figure 49).
8. Press the LEFT (◀) button twice to return to the rolling status screens

SETTING RECHARGE TIME

When the filter's electronic control is first powered up, the default time for starting an automatic recharge is 12:00 a.m. This is a good time in most households because water is not being used. To change this time:

1. From any of the rolling status screens, press the SELECT (O) button to display the **Main menu**.
2. Press the DOWN (▼) button to scroll through the menu options until **Basic settings** is highlighted (See Figure 51).

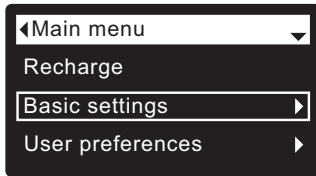

FIG. 51

3. Press the SELECT (O) button to display the Basic settings menu (See Figure 52).

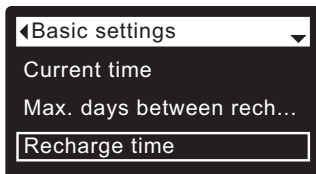

FIG. 52

4. Press the DOWN (▼) button to scroll through the menu options until **Recharge time** is highlighted.
5. Press the SELECT (O) button to display the Recharge time screen (See Figure 53).

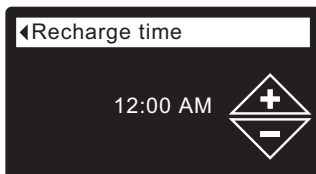

FIG. 53

6. Press the UP (▲) or DOWN (▼) buttons to change the recharge time in 1 hour increments. Hold the button down to rapidly advance. Be sure that AM or PM is correct (unless filter is set for a 24-hour clock).
7. Press the SELECT (O) button. The display will go back to the Basic settings menu (Figure 52).
8. Press the LEFT (◀) button twice to return to the rolling status screens.

MODIFYING ROLLING SCREENS

During normal filter operation, up to four status screens are shown in sequence (See "Filter Status Screens" on Page 14). When the filter's electronic control is first powered up, the default is to show all four. You can turn on/off individual screens*:

1. From any of the rolling status screens, press the SELECT (O) button to display the **Main menu**.
2. Press the DOWN (▼) button to scroll through the menu options until **Basic settings** is highlighted (See Figure 54).

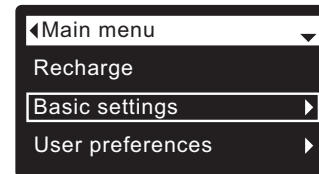

FIG. 54

3. Press the SELECT (O) button to display the Basic settings menu (See Figure 55).

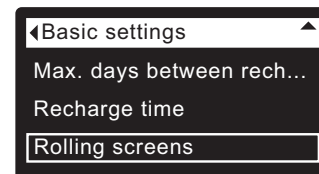

FIG. 55

4. Press the DOWN (▼) button to scroll through the menu options until **Rolling screens** is highlighted.
5. Press the SELECT (O) button to display the Rolling screens menu (See Figure 56).

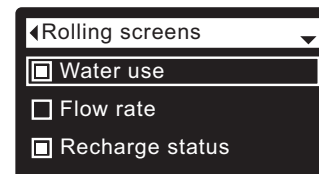

FIG. 56

6. Press the DOWN (▼) or UP (▲) buttons to scroll through the list. Items with a black square next to them will be displayed during normal operation.
7. To un-select a screen, make sure its name is highlighted in a box. Then press the SELECT (O) button. The black square will disappear. Pressing SELECT (O) again makes the black square reappear and re-selects the highlighted item. At least one screen must be selected/highlighted.
8. When selections are complete, exit this menu by pressing the LEFT (◀) button. The display will go back to the Basic settings menu (Figure 55).
9. Press the LEFT (◀) button twice to return to the rolling status screens.

*This does not include service reminders, errors, alerts or Recharge status screens.

SETTING THE LANGUAGE

When the filter's electronic control is first powered up, a "wizard" screen prompts you to set the language (See Page 10). To change the language:

1. From any of the rolling status screens, press the SELECT (O) button to display the **Main menu**.
2. Press the DOWN (▼) button to scroll through the menu options until **User preferences** is highlighted (See Figure 57).

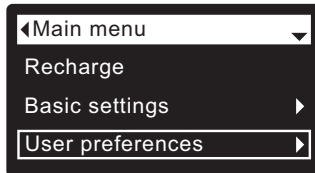

FIG. 57

3. Press the SELECT (O) button to display the User preferences menu (See Figure 58).

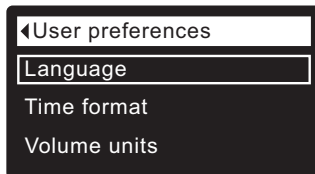

FIG. 58

4. Make sure **Language** is highlighted.
5. Press the SELECT (O) button to display the Language menu (See Figure 59).



FIG. 59

6. If the desired language already has a dot next to it (See Figure 59), go to Step 7. Otherwise, press the DOWN (▼) or UP (▲) buttons to scroll to the desired language, then press SELECT (O) to choose it. The choices are: English, Spanish, French, Italian, German, Dutch, Polish, Russian, Hungarian, Turkish, Lithuanian, Greek, Romanian, Czech, Slovak, Bulgarian, Serbian or Croatian.
7. Press the SELECT (O) button. The display will go back to the User preferences menu (Figure 58).
8. Press the LEFT (◀) button twice to return to the rolling status screens.

TO SET THE FILTER TO ENGLISH IF ANOTHER LANGUAGE IS DISPLAYED:

From the rolling status screens, press SELECT (O). Press DOWN (▼) three times, then press SELECT (O) twice. Press UP (▲) to scroll to **English** at the top of the list, then press SELECT (O) twice. Press LEFT (◀) twice to exit all menus.

SETTING TIME FORMAT

Use this feature to select a 12-hour (AM/PM) or 24-hour clock.

1. From any of the rolling status screens, press the SELECT (O) button to display the **Main menu**.
2. Press the DOWN (▼) button to scroll through the menu options until **User preferences** is highlighted.
3. Press the SELECT (O) button to display the User preferences menu.
4. Press the DOWN (▼) button to scroll through the menu options until **Time format** is highlighted.
5. Press the SELECT (O) button to display the Time format menu (See Figure 60).

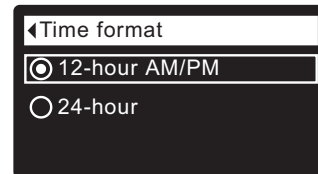

FIG. 60

6. If the desired time format already has a dot next to it (See Figure 60), go to Step 7. Otherwise, press the DOWN (▼) or UP (▲) buttons to scroll to the other time format, then press SELECT (O) to choose it.
7. Press the SELECT (O) button. The display will go back to the User preferences menu.
8. Press the LEFT (◀) button twice to return to the rolling status screens.

SETTING VOLUME UNITS

Use this feature to select gallons or liters as volume units.

- 1-3. Go to the **User preferences** menu by following Steps 1-3 in "Setting Time Format" above.
4. Press the DOWN (▼) button to scroll through the menu options until **Volume units** is highlighted.
5. Press the SELECT (O) button to display the Volume units menu (See Figure 61).

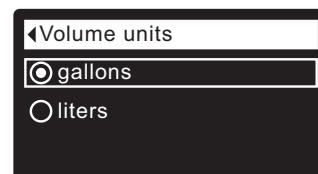

FIG. 61

6. If the desired volume unit already has a dot next to it (See Figure 61), go to Step 7. Otherwise, press the DOWN (▼) or UP (▲) buttons to scroll to the other volume unit, then press SELECT (O) to choose it.
7. Press the SELECT (O) button. The display will go back to the User preferences menu.
8. Press the LEFT (◀) button twice to return to the rolling status screens.

SYSTEM INFORMATION

Use these features to look up the following information about the filter and its operations:

- **Model information** (model number and software version)
- **Wireless information**
- **Daily average water used**
- **Water used today**
- **Total water used** (explained in Step 6, below)
- **Current water flow**
- **Days powered up**
- **Last recharge**
- **Total recharges**

To display one of these screens:

1. From any of the rolling status screens, press the SELECT (O) button to display the **Main menu**.
2. Press the DOWN (▼) button to scroll through the menu options until **System information** is highlighted (See Figure 62).

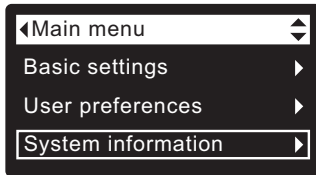

FIG. 62

3. Press the SELECT (O) button to display the System information menu (See Figure 63).

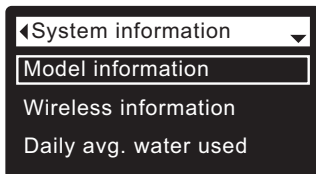

FIG. 63

4. Press the DOWN (▼) button to scroll through the menu options until the desired option is highlighted (See list at the top of this column).
5. Press the SELECT (O) button to display the desired information screen (See Figures 64-72).
6. The **Total water used** screen (See Figure 68) shows the volume of water used since it was last reset (it works like the trip odometer in a car). To reset the value to 0, press the RIGHT (▶) button while this screen is displayed.
7. When finished viewing an information screen, press the SELECT (O) button. The display will go back to the System information menu (Figure 63). It will also exit automatically if no buttons are pressed for four minutes.
8. Press the LEFT (◀) button twice to return to the rolling status screens.

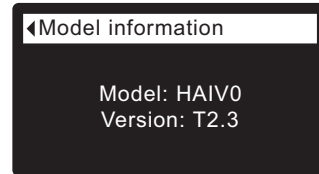

FIG. 64

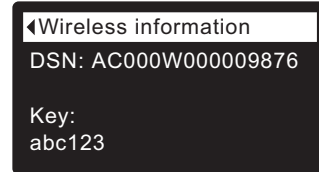

FIG. 65

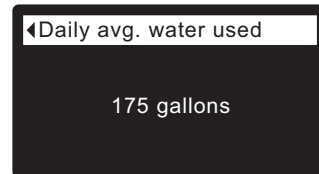

FIG. 66

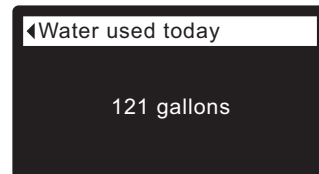

FIG. 67

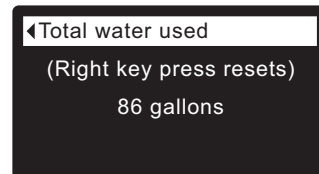

FIG. 68

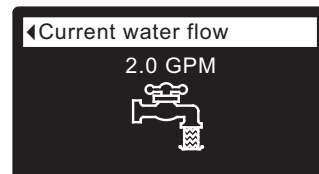

FIG. 69

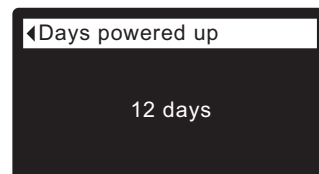

FIG. 70

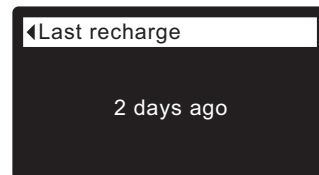

FIG. 71

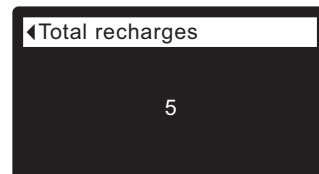

FIG. 72

CYCLE TIMES

Use these features to change the following filter operations:

- **Backwash time**
- **Fast rinse time** (aspirate time)

To display these screens:

1. From any of the rolling status screens, press the SELECT (O) button to display the **Main menu**.
2. Press the DOWN (▼) button to scroll through the menu options until **Advanced settings** is highlighted (See Figure 73).

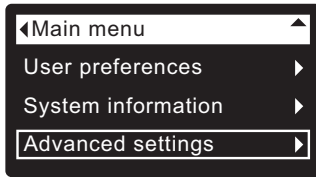

FIG. 73

3. Press the SELECT (O) button to display the Advanced settings menu (See Figure 74).

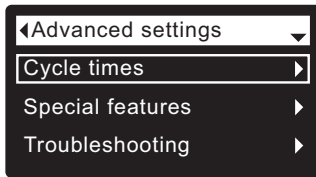

FIG. 74

4. Make sure **Cycle times** is highlighted.
5. Press the SELECT (O) button to display the Cycle times menu (See Figure 75).

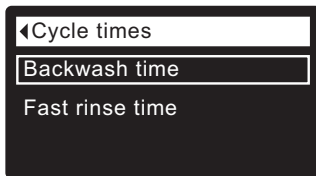

FIG. 75

6. Press the DOWN (▼) button to scroll through the menu options until the desired option is highlighted (See list at the top of this column).
7. Press the SELECT (O) button to display the desired cycle time screen (See Figures 76 & 77).
8. **See the right column on this page for specific instructions on each cycle time screen.**
9. Press the SELECT (O) button. The display will go back to the Cycle times menu (Figure 75).
10. Press the LEFT (◀) button three times to return to the rolling status screens.

- 8a. **Backwash time:** Press the UP (▲) or DOWN (▼) buttons to change the backwash time. Hold the button down to rapidly advance. The backwash time can be set from 1 to 99 minutes* (See Figure 76).

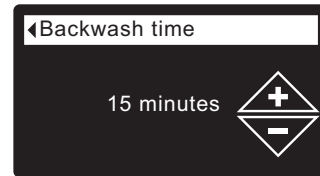

FIG. 76

- 8b. **Fast rinse time:** Press the UP (▲) or DOWN (▼) buttons to change the fast rinse time (aspirate time). Hold the button down to rapidly advance. The fast rinse time can be set from 1 to 99 minutes* (See Figure 77).

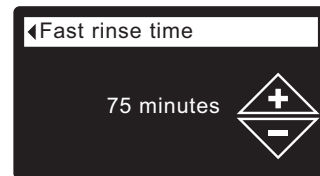

FIG. 77

*Reducing the backwash and fast rinse times below a filter model's default settings is not recommended.

SPECIAL FEATURES

Use these features to change the following operations:

- **Auxiliary control** (described on Page 24)
- **Chemical feed volume**** (described on Page 24)
- **Chemical feed timer**** (described on Page 24)
- **Service reminder** (described below)

SERVICE REMINDER (set / reset)

Use this feature to program the number of months (up to 24) before a “Service overdue” message will appear instead of the rolling status screens (See Figure 78).

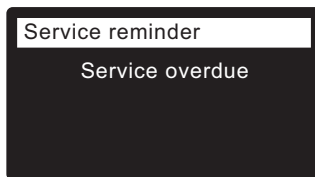

FIG. 78

This will be a reminder to call your dealer for service. Once programmed, this feature displays the number of months and days left until the service reminder.

Once the “Service overdue” message has appeared, dealers performing service clear it by setting the number of months until the next service reminder. Set or reset the service reminder as follows:

1. From any of the rolling status screens, press the SELECT (O) button to display the **Main menu**.
2. Press the DOWN (▼) button to scroll through the menu options until **Advanced settings** is highlighted.

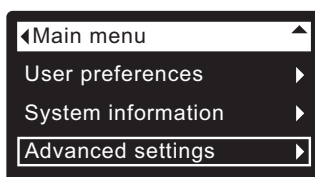

FIG. 79

3. Press the SELECT (O) button to display the Advanced settings menu (See Figure 80).

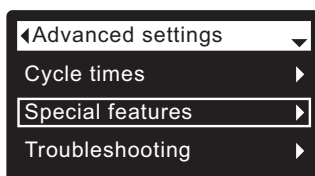

FIG. 80

4. Press the DOWN (▼) button to scroll through the menu options until **Special features** is highlighted.
5. Press the SELECT (O) button to display the Special features menu (See Figure 81).

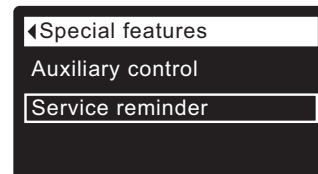

FIG. 81

6. Press the DOWN (▼) button to scroll through the menu options until **Service reminder** is highlighted.
7. Press the SELECT (O) button to display the Service reminder screen (See Figure 82).

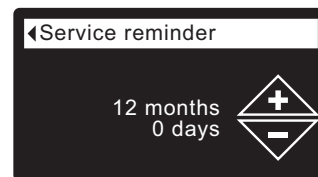

FIG. 82

8. Press the UP (▲) or DOWN (▼) buttons to set the number of months until the service reminder appears. Repeatedly pressing the DOWN (▼) button until the display reads “Off” turns this feature off and zeros the number of months and days.
9. Press the SELECT (O) button. The display will go back to the Special features menu (Figure 81).
10. Press the LEFT (◀) button three times to return to the rolling status screens.

**Only displayed if Auxiliary control is set to Chemical feed.

AUXILIARY CONTROL

The electronic control has an auxiliary output which can control external devices in a water treatment system. The signal is 24V DC, current draw 500 mA maximum. The Auxiliary Output terminals are located on the electronic control board (See Schematic on Page 31).

For more details on the use of auxiliary controlled equipment in water treatment systems, consult the EcoWater Systems "Problem Water Guide."

To select an auxiliary control mode:

1. From any of the rolling status screens, press the SELECT (O) button to display the **Main menu**.
2. Press the DOWN (▼) button to scroll through the menu options until **Advanced settings** is highlighted.
3. Press the SELECT (O) button to display the Advanced settings menu.
4. Press the DOWN (▼) button to scroll through the menu options until **Special features** is highlighted.
5. Press the SELECT (O) button to display the Special features menu (See Figure 83).

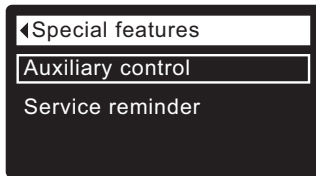

FIG. 83

6. Make sure **Auxiliary control** is highlighted.
7. Press the SELECT (O) button to display the Auxiliary control menu (See Figure 84).
8. If the desired option already has a black dot next to it (See Figure 84), go to Step 9. Otherwise, press the DOWN (▼) or UP (▲) buttons to scroll to the desired option, then press SELECT (O) to choose it.
 - **Off** is the default. The 24V DC output is always off.
 - **On**: The 24V DC output is always on.
 - **Chlorine** can be used to drive a chlorine generator, which produces chlorine, as water passes through it, to sanitize the media during recharges.
 - **Bypass**: Turns 24V DC on during the entire regeneration cycle (when the filter's valve is in bypass and unfiltered is going to the house).
 - **Chemical feed**:* Can be used to run a chemical feed pump. If chosen, the chemical feed volume and timer must be set, as detailed at right.
 - **Water use***: Turns 24V DC on when the filter's turbine indicates water flow. Could drive an air pump for iron or sulfur oxidation.
 - **Fast Rinse**: Turns 24V DC on during the fast rinse portion of the regeneration cycle.
9. Press the SELECT (O) button. The display will go back to the Special features menu (Figure 83).
10. Press the LEFT (◀) button three times to return to the rolling status screens.

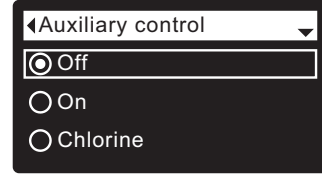

FIG. 84

CHEMICAL FEED*

If the auxiliary control mode has been set to **Chemical feed**, as described in the previous section, two additional lines (**Chemical feed volume** and **Chemical feed timer**) will appear on the Special features menu.

To set these values:

1. From any of the rolling status screens, press the SELECT (O) button to display the **Main menu**.
2. Press the DOWN (▼) button to scroll through the menu options until **Advanced settings** is highlighted.
3. Press the SELECT (O) button to display the Advanced settings menu.
4. Press the DOWN (▼) button to scroll through the menu options until **Special features** is highlighted.
5. Press the SELECT (O) button to display the Special features menu (See Figure 83).
6. Press the DOWN (▼) button to scroll through the menu options until **Chemical feed volume** or **Chemical feed timer** is highlighted.
7. Press the SELECT (O) button to display the Chemical feed volume or Chemical feed timer menu (See Figures 85 & 86).

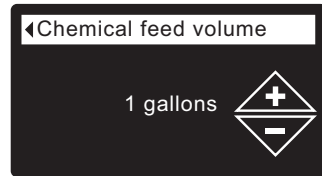

FIG. 85

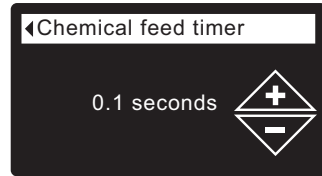

FIG. 86

8. Press the UP (▲) or DOWN (▼) buttons to change the value. Hold the button down to rapidly advance.
 - **Chemical feed volume** is the amount of water which will pass through the filter between each activation of the chemical feed equipment.
 - **Chemical feed timer** is how long the output to the chemical feed equipment is energized each time it is activated.
9. Press the SELECT (O) button. The display will go back to the Special features menu (Figure 83).
10. Press the LEFT (◀) button three times to return to the rolling status screens.

* A turbine and turbine cable must be added to the system if auxiliary control options "Chemical feed" or "Water use" are to be used.

DIAGNOSTICS

This feature allows a service technician to check the operating state of individual components in the filter (e.g. valve position) to troubleshoot problems. **If an error code is displayed in place of the rolling status screens, call your dealer for service.**

To view the Diagnostics screen:

1. If an error code is displayed, skip Steps 2-7 and go directly to Step 8.
2. To display the Diagnostics screen from any of the rolling status screens (when an error code is not displayed), press the SELECT (O) button to display the **Main menu**.
3. Press the DOWN (▼) button to scroll through the menu options until **Advanced settings** is highlighted.
4. Press the SELECT (O) button to display the Advanced settings menu.
5. Press the DOWN (▼) button to scroll through the menu options until **Troubleshooting** is highlighted.
6. Press the SELECT (O) button to display the Troubleshooting menu (See Figure 87).

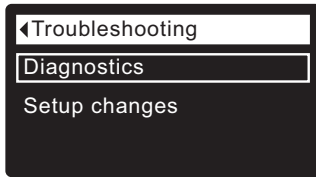

FIG. 87

7. Make sure **Diagnostics** is highlighted.
8. Press the SELECT (O) button to display the Diagnostics screen (See Figure 88).

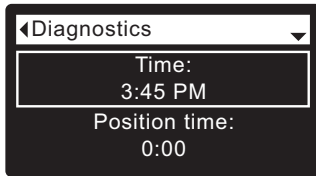

FIG. 88

9. Press the DOWN (▼) or UP (▲) buttons to scroll through the list. The following items are displayed:
 - **Time** (current)
 - **Position time** (counts down the time remaining in the current valve position)
 - **Current position** (of the valve: service, fill, brine, backwash, fast rinse or moving)
 - **Requested position** (of the valve)
 - **Motor state** (on or off)
 - **Valve position switch** (open or closed)
 - **Turbine count** (if changing, indicates water flow)
 - **Tank light switch** (open or closed)
 - **RF module** (detected or not)
 - **Error code** (call for service if a number is displayed)

continued

10. When finished viewing the Diagnostics screen, press the SELECT (O) button. The display will go back to the Troubleshooting menu.
11. Press the LEFT (◀) button three times to return to the rolling status screens (or error code screen if an error condition exists).

SETUP CHANGES

This feature allows a service technician to repeat the setup procedure (See Pages 10-12) or restore the filter's default operating values.

1. From any of the rolling status screens, press the SELECT (O) button to display the **Main menu**.
2. Press the DOWN (▼) button to scroll through the menu options until **Advanced settings** is highlighted.
3. Press the SELECT (O) button to display the Advanced settings menu.
4. Press the DOWN (▼) button to scroll through the menu options until **Troubleshooting** is highlighted.
5. Press the SELECT (O) button to display the Troubleshooting menu (See Figure 87).
6. Press the DOWN (▼) button to scroll through the menu options until **Setup changes** is highlighted.
7. Press the SELECT (O) button to display the Setup changes menu (See Figure 89).

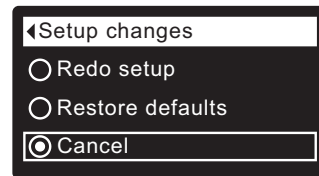

FIG. 89

8. If the desired option already has a dot next to it (See Figure 89), go to Step 9. Otherwise, press the DOWN (▼) or UP (▲) buttons to scroll to the desired option, then press SELECT (O) to choose it.
 - **Redo setup** allows you to select a different model code (intended to be used for upgrades or retrofits of existing filters). Model codes are listed on Page 3.
 - **Restore defaults** will reset all customizable settings to their default values and take you through the "wizard" screen setup procedure (See Pages 10-12).
 - **Cancel** will return to the Troubleshooting menu (Figure 87).
9. Press the SELECT (O) button.

CLEANING THE NOZZLE & VENTURI

A clean nozzle & venturi (See Figure 90) is a necessity for the water filter to work properly. This small component creates the suction to aspirate (bring air into) the mineral tank during recharges. If it should become plugged with sand, silt, dirt, etc., the water filter will not work to remove iron from the water.

To get access to the nozzle & venturi, remove the water filter's top cover. Put the bypass valve(s) into the bypass position. Be sure the water filter's main valve is in "service" position (no water pressure at nozzle & venturi). Then, holding the nozzle & venturi housing with one hand, unscrew the cap. Do not lose the o-ring seal. Lift out the screen support and screen. Then, remove the nozzle & venturi disc, gasket and flow plug. Wash the parts in warm, soapy water and rinse in fresh water. Be sure to clean both the top and bottom of the nozzle & venturi disc. If needed, use a small brush to remove iron or dirt. Do not scratch, misshape, etc., surfaces of the nozzle & venturi.

Gently replace all parts in the correct order. Lubricate the o-ring seal with silicone grease and locate in place. Install and tighten the cap by hand, while supporting the housing. Overtightening may break the cap or housing. Put the bypass valve(s) into "service" position.

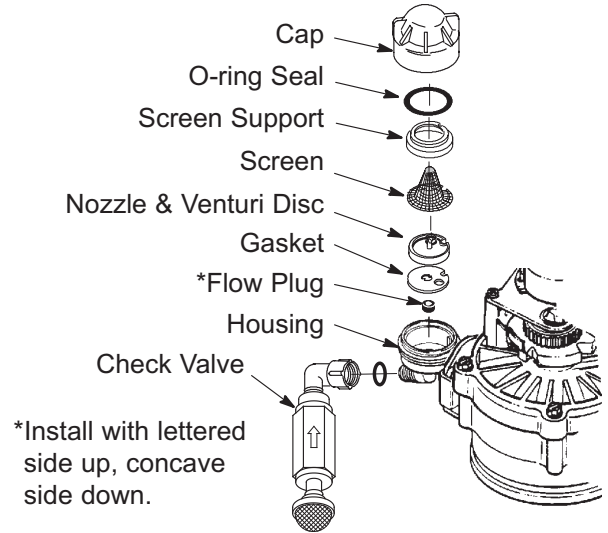

IMPORTANT: Be sure small hole in the gasket is centered directly over the small hole in the nozzle & venturi housing. Be sure the numbers are facing up

FIG. 90

Recharge the filter and advance the valve to the "aspirate" (A) position. Remove the screen from the barbed fitting on the inlet of the check valve and determine whether there is suction. Put the screen back in place when finished checking.

RELIEVING WATER PRESSURE WITH THE BYPASS VALVE(S)

CAUTION: Always relieve water pressure in the EcoWater Systems filter, as described below, before removing parts from the valve or media tank.

DE-PRESSURIZE

1. Put bypass valve(s) into **Bypass** position.
2. Place filter valve in **Fill** position by performing Steps 1 & 5 of Manual Advance Recharge procedure on Page 30.

PRESSURIZE

1. Put bypass valve(s) into **Service** position.
2. Return filter valve to **Service** position by performing Steps 8 & 9 of Manual Advance Recharge procedure on Page 30.

ALTERNATE METHODS:

3-VALVE BYPASS (See Figure 91)

DE-PRESSURIZE

1. Close the INLET valve.
2. Open HOT and COLD conditioned water house faucets.
3. Close the OUTLET valve and open the BYPASS valve.
4. Close all house faucets.

PRESSURIZE

1. Open HOT and COLD house faucets.
2. Close the BYPASS valve and open the OUTLET valve.
3. **Slowly**, open the INLET valve.
4. Close all house faucets.

ECOWATER SYSTEMS BYPASS VALVE

(See Figure 92)

DE-PRESSURIZE

1. Close the house main water supply valve.
2. Open HOT and COLD conditioned water house faucets.
3. Push the bypass valve handle to **Bypass** position.
4. Optional: For unfiltered water bypass to house faucets, reopen the main water supply valve.

PRESSURIZE

1. Open main water supply valve if it is closed.
2. Open HOT and COLD house faucets.
3. Pull the bypass valve handle to **Service** position.
4. Close all house faucets.

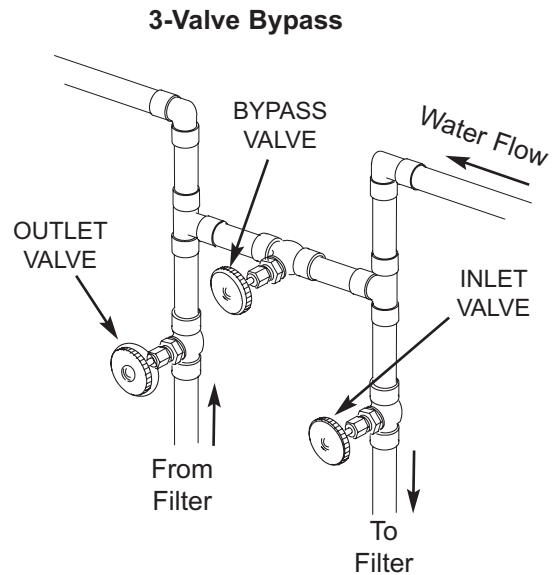

For Service
Close Bypass Valve.
Open Inlet & Outlet
Valves.

For Bypass
Open Bypass Valve.
Close Inlet & Outlet
Valves.

FIG. 91

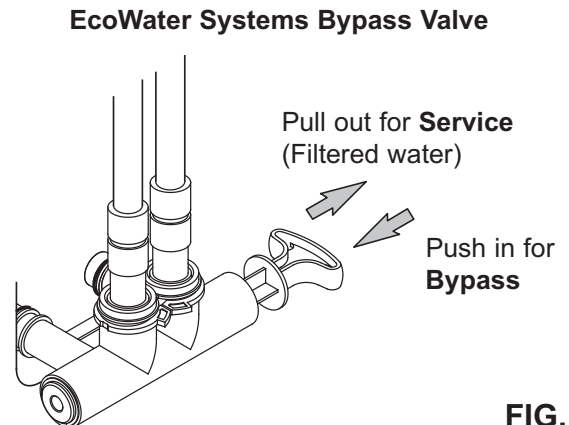



FIG. 92

TROUBLESHOOTING GUIDE		
PROBLEM	CAUSE	CORRECTION
Cannot set some filter parameters and display shows a padlock icon: 	Lockout feature is on.	Turn off lockout feature (See Page 16).
Status screen shows "No automatic recharges"	Recharge is set to "Off" (vacation mode).	If you want automatic recharges, set recharge to either "Schedule" or "Automatic" (See Page 17).
Iron bleed	Riser tube o-ring.	Reseat or replace riser o-ring.
	Over-running filter bed.	Increase recharge frequency and backwash time.
	Time clock set incorrectly.	Check and change time.
	Increase in iron.	Increase recharge frequency and backwash time.
	Restricted drain line or drain flow control	Clear drain line or drain flow control.
	Plugged nozzle & venturi - no suction in aspirate cycle.	Clean nozzle & venturi (See Page 26).
Air in house lines	Riser tube o-ring.	Reseat or replace riser o-ring.
Water to drain	Defective rotor disc and seals.	Replace rotor disc and seals.
Motor stalled or clicking	Motor malfunction or internal valve fault causing high torque on motor.	Contact your dealer for service.
Error code E1, E3 or E4 displayed.	Fault in wiring harness, connections to position switch, switch, valve or motor.	Contact your dealer for service.
Error code E5 displayed.	Electronic control malfunction.	Contact your dealer for service.

TROUBLESHOOTING - INITIAL CHECKS

Always make these initial checks first:

1. Is display blank? Check power source.
2. Is Error code displayed? If so, go to "Automatic Electronic Diagnostics" on the next page.
3. Is correct time displayed? If not, recharges occur at the wrong time. Set current time (See Page 15.)
4. Are plumbing bypass valve(s) in service position (See Figures 91 & 92 on Page 27)?
5. Are inlet and outlet pipes connected to the EcoWater filter inlet and outlet respectively?
6. Is valve drain hose free of kinks and sharp bends, and not elevated over 8 feet above the floor.

If no problem is found after making the initial checks, proceed to "Troubleshooting - Manual Diagnostics" and "Manual Advance Recharge Check" on the next two pages.

AUTOMATIC ELECTRONIC DIAGNOSTICS

This filter has a self-diagnostic function for the electrical system (except for input power and/or water meter). The controller monitors electronic components and circuits for correct operation. If a malfunction occurs, an **Error code** is displayed (See Figure 93).

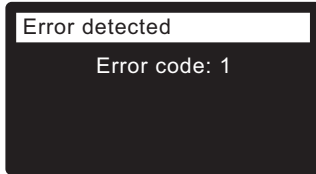

FIG. 93

The troubleshooting chart on the previous page shows the error codes that could appear, and the possible malfunctions for these codes.

When an error code appears in the display, pressing SELECT (O) will display the **Diagnostics** screen (See Page 25), so a service technician can further isolate the problem.

REMOVING ERROR CODE

1. Unplug power supply from electrical outlet.
2. Correct problem.
3. Plug power supply back in.
4. Wait for 8 minutes while controller operates valve through an entire cycle. The error code will return if the problem was not corrected.

TROUBLESHOOTING - MANUAL DIAGNOSTICS

1. Display the **Diagnostics** screen, following the procedure on Page 25.
2. Press the DOWN (▼) or UP (▲) buttons to scroll through the list. The following items are displayed:
 - **Time** (current)
 - **Position time** (counts down the time remaining in the current valve position)
 - **Current position** (of the valve: service, fill, brine, backwash, fast rinse or moving) See “Manual Advance Recharge Check” on the next page for position verification.
 - **Requested position** (of the valve)
 - **Motor state** (on or off)
 - **Valve position switch** (open or closed)
 - **Turbine count** (if changing, indicates water flow) See following section for turbine diagnostics.
 - **Tank light switch** (open or closed)
 - **RF module** (detected or not)
 - **Error code**

CHECKING THE TURBINE

1. Display the **Diagnostics** screen, following the procedure on Page 25.
2. Press the DOWN (▼) button to scroll through the list until **Turbine Count** is displayed (See Figure 94).

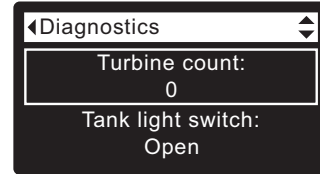

FIG. 94

3. A steady display of “0” (zero) indicates no water flow through the meter (i.e. no conditioned water being used).
4. Open a nearby conditioned water faucet.
5. The number in the display should count upward from 0 and reset at 140 for each gallon of flow.
6. If the display reading does not change with the faucet open, pull the wire harness from the valve outlet port (See Figure 95).

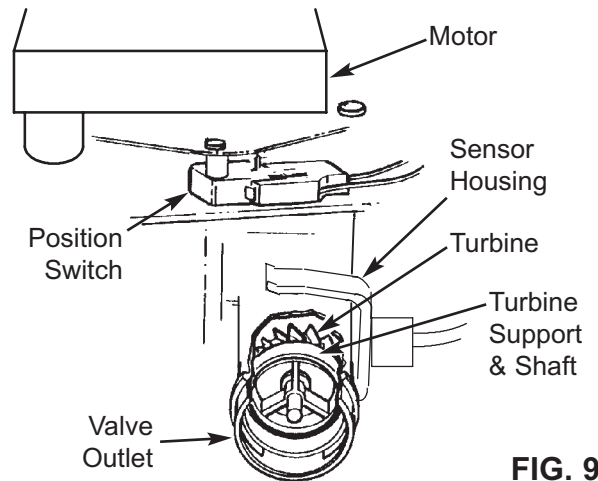

FIG. 95

7. Pass a small magnet back and forth in front of the sensor.
- 8a. If the displayed **Turbine Count** does count upward with each pass of the magnet, disconnect the outlet plumbing and check the turbine for binding.
- 8b. If the displayed **Turbine Count** does not count upward with each pass of the magnet, the sensor is probably faulty.

**TROUBLESHOOTING -
MANUAL ADVANCE RECHARGE CHECK**

Use the following procedures to advance the filter through the recharge cycles to check operation. Always make the Initial Checks (See Page 28) and the Manual Diagnostics (See Page 29) first.

Remove the top cover by unlocking the tabs and lifting, to observe cam and switch operation during valve rotation (See Figure 98).

1. Display the **Diagnostics** screen, following the procedure on Page 25.
2. Press the DOWN (▼) button to scroll through the list until **Valve position switch** is displayed (See Figure 96).

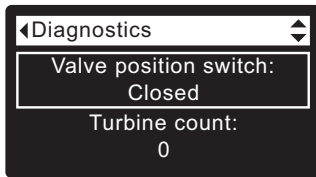

FIG. 96

3. Verify that when the switch plunger is down (into one of the detents on the valve motor cam), this screen reads **Open**. When the valve cam is rotating (for example, after Step 5, below), the switch plunger will be up and this screen should read **Closed**.
4. Press the UP (▲) button to scroll through the list until **Current position** is displayed (See Figure 97).

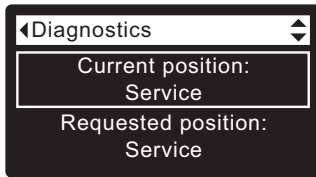

FIG. 97

5. With the Diagnostics screen displayed, press the RIGHT (▶) button once to advance the valve from **Service** to **Backwash**.
6. Verify that the valve position indicator on the motor cam agrees with the position displayed on the screen
7. Look for a fast flow of water from the drain hose. If flow is slow, check for a plugged top distributor, backwash flow plug or drain hose
8. With the Diagnostics screen displayed, once again press the RIGHT (▶) button to advance the valve to **Fast rinse** (Aspirate).
9. With the Diagnostics screen displayed, once again press the RIGHT (▶) button to return the valve to the **Service** position.

IMPORTANT: Always return the valve to the **Service** position before exiting this procedure.

OTHER SERVICE

Unfiltered Water Bypass (Unfiltered water “bleeds” into filtered water supply):

1. Faulty rotor disc, seal or wave washer (See Pages 34 & 35).
2. Missing or faulty o-ring(s) at valve connection to riser pipe.

Water Leaks from Drain Hose during service:

1. Faulty rotor disc, seal or wave washer.
2. Faulty o-ring on inlet disc shaft.

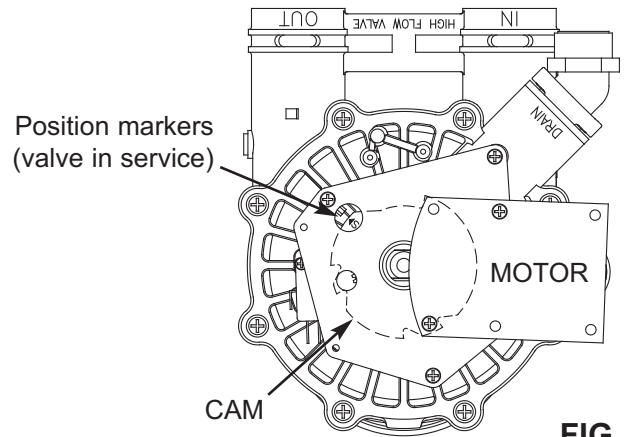
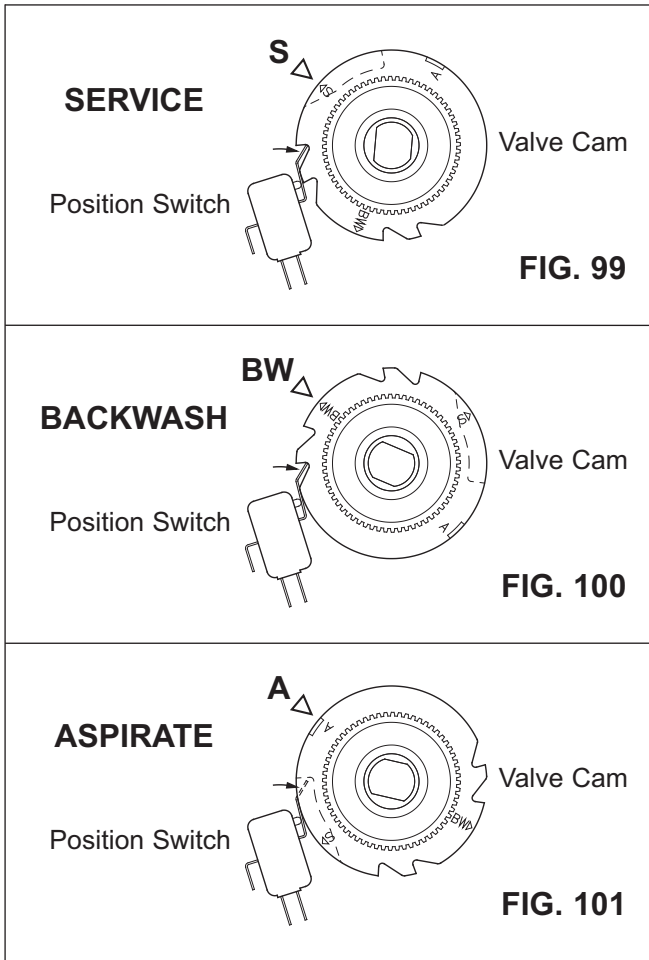
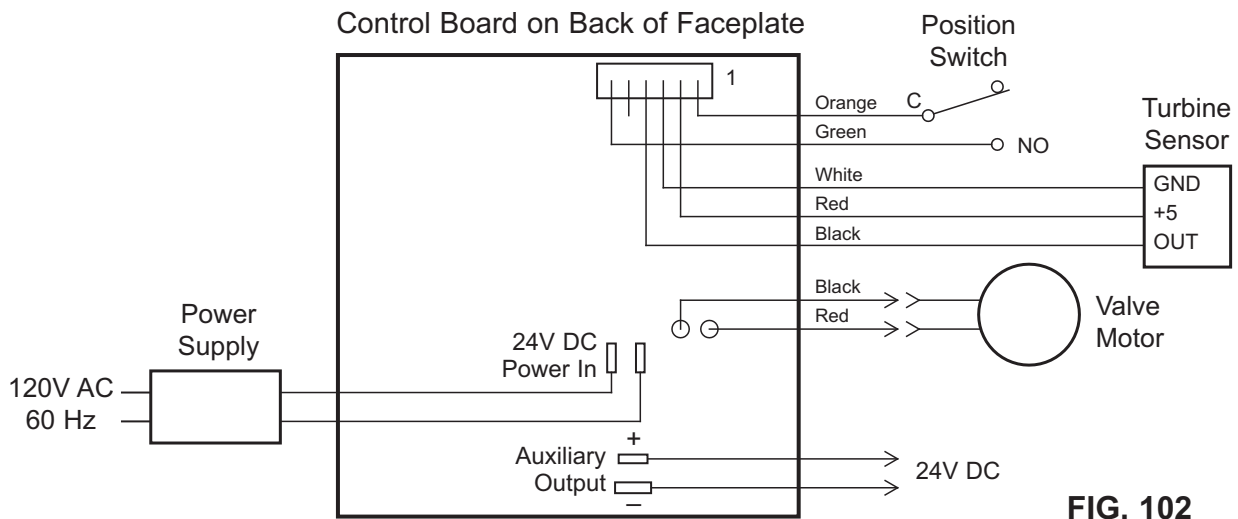

FIG. 98



WIRING SCHEMATIC



FILTER EXPLODED VIEW

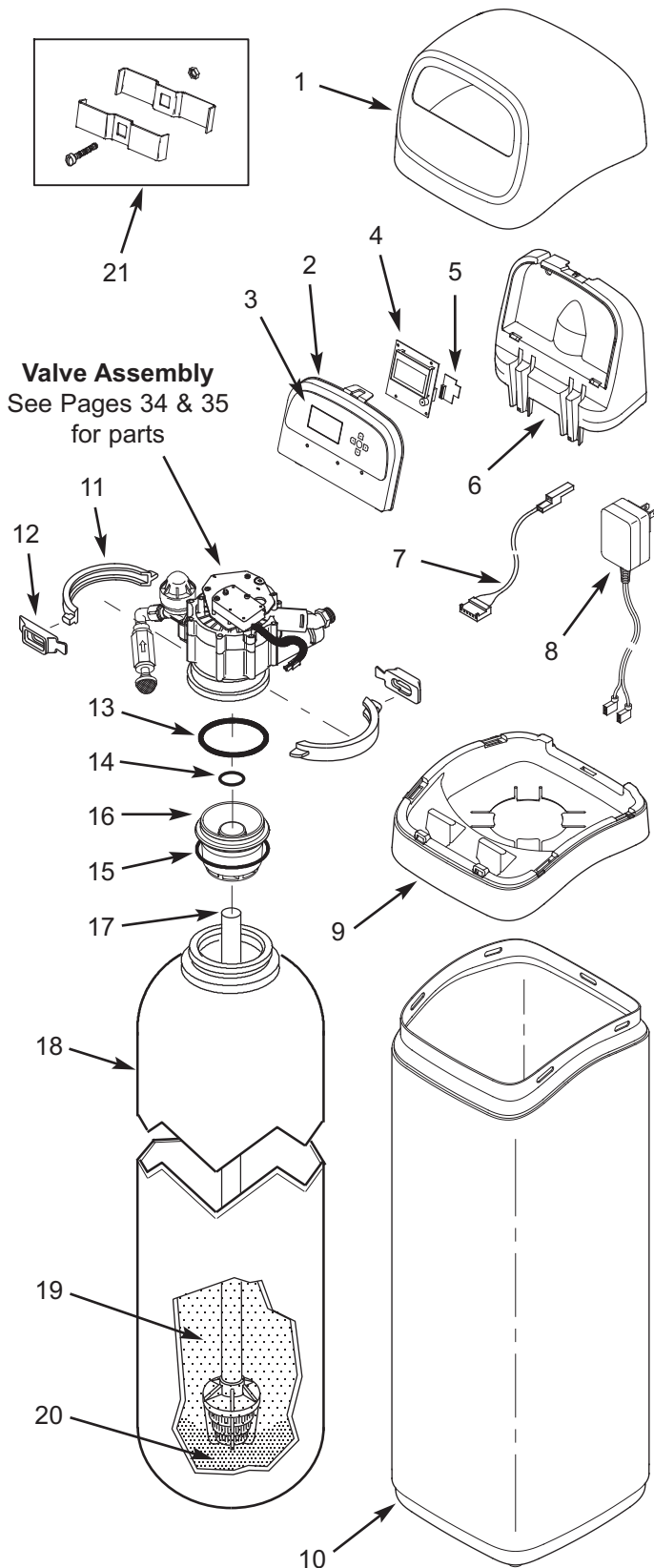

FILTER PARTS LIST

Key No.	Part No.	Description
1	7353365	Top Cover
-	7369586	Repl. Faceplate Assembly (includes Key Nos. 2-4)
2	↑	Faceplate
3	↑	Keypad/Decal
4	↑	Electronic Controller (PWA)
5	7341520	Repl. Wi-Fi Board
6	7353381	Support, Faceplate
7	7309811	Wire Harness, Position Switch
8	7351054	Power Supply, 24V DC
9	7353357	Rim
10	7353234	Shroud, ETF2300AIV10 & ETF2300EIV10
	7353242	Shroud, ETF2300AIV12 & ETF2300EIV12
-	7331177	Tank Neck Clamp Kit (includes 2 ea. of Key Nos. 11 & 12)
11	↑	Clamp Section (2 req.)
12	↑	Retainer, Clamp (2 req.)
-	7112963	Distributor O-Ring Kit (includes Key Nos. 13-15)
13	↑	O-Ring, 2-7/8" x 3-1/4"
14	↑	O-Ring, 13/16" x 1-1/16"
15	↑	O-Ring, 2-3/4" x 3"
16	7335757	Top Distributor
17	7105047	Repl. Bottom Distributor
18	7092202	Repl. Mineral Tank, 10" x 47", ETF2300AIV10 & ETF2300EIV10
	7113074	Repl. Mineral Tank, 12" x 54" ETF2300AIV12 & ETF2300EIV12
19	7351046	Zeolite Media, 50 lbs. (media not included with ETF2300EIV10 & ETF2300EIV12)
20	7124415	Gravel, 17 lbs.
21	7248706	Ground Clamp Kit *

* Not included with the filter.

To order parts, call your local EcoWater dealer or go to www.ecowater.com to locate a dealer in your area.

VALVE EXPLODED VIEW

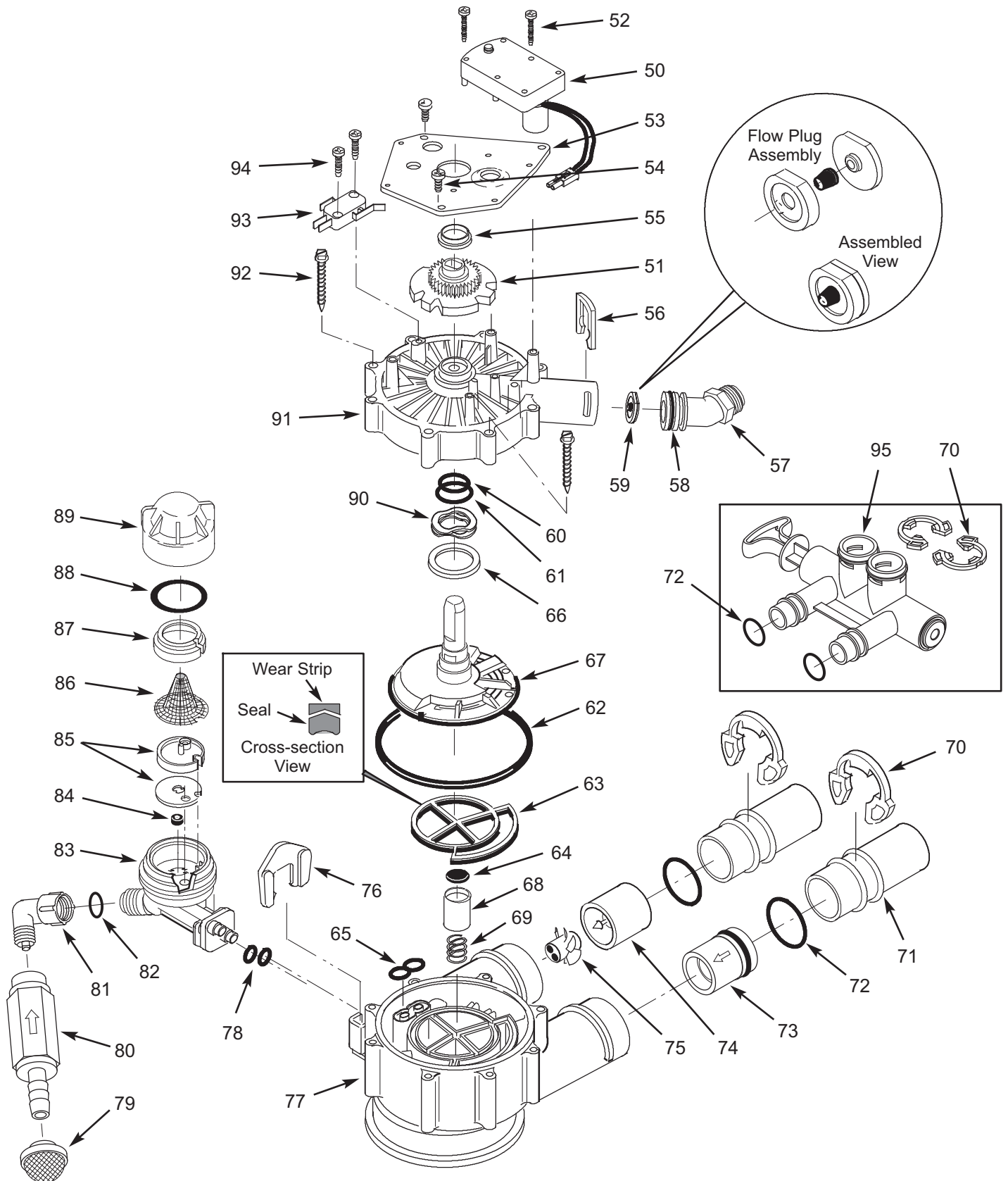

VALVE PARTS LIST

Key No.	Part No.	Description
–	7384706	Motor, Cam & Gear Kit, AIV (includes Key Nos. 50-52)
50	↑	Motor
51	↑	Cam & Gear
52	7224087	Screw, #8-32 x 1" (2 req.)
53	7231393	Motor Plate
54	0900857	Screw, #6-20 x 3/8" (3 req.)
55	7171250	Bearing
56	7169180	Clip, Drain
57	7172793	Drain Hose Adaptor
58	7170288	O-Ring, 15/16" x 1-3/16", single
	7336402	O-Ring, 15/16" x 1-3/16", pack of 20
59	7178202	Flow Plug, 7 gpm, ETF2300AIV10 & ETF2300EIV10
	7178210	Flow Plug, 10 gpm, ETF2300AIV12 & ETF2300EIV12
–	7185487	Seal Kit (includes Key Nos. 60-65)
60	↑	O-Ring, 5/8" x 13/16"
61	↑	O-Ring, 1-1/8" x 1-1/2"
62	↑	O-Ring, 4-1/2" x 4-7/8"
63	↑	Rotor Seal
64	↑	Seal
65	↑	Seal, Nozzle & Venturi
66	7174313	Bearing, Wave Washer
67	7335058	Rotor & Disc
68	7171187	Plug, Drain Seal
69	7129889	Spring
70	7089306	Clip, 1", single (2 req.)
	7336428	Clip, 1", pack of 20
71	7077642	Copper Tube, 1", single (2 req.)
	7344138	Copper Tube, 1", pack of 10 (includes 10 ea. of Key No. 72)
72	7311127	O-Ring, 1-1/16" x 1-5/16", single (2 req.)
	7336410	O-Ring, 1-1/16" x 1-5/16", pack of 20

Key No.	Part No.	Description
73	7343873	Inlet Check Valve w/O-Ring
–	7331703	Turbine & Support Assembly, including 2 O-Rings (See Key No. 72) & 1 ea. of Key Nos. 74 & 75
74	↑	Turbine Support & Shaft
75	↑	Turbine
76	7081201	Retainer, Nozzle & Venturi
77	7171145	Valve Body
78	7170319	O-Ring, 1/4" x 3/8" (2 req.)
79	7336208	Air Inlet Screen
80	7336193	Aspirator Check Valve
81	7120526	Elbow, 90°
82	7292323	O-Ring, 3/16" x 7/16"
–	7085247	Nozzle & Venturi Assembly (includes Key Nos. 83-89)
83	7081104	Housing, Nozzle & Venturi
84	1148800	Flow Plug, .3 gpm
85	7114533	Nozzle & Venturi Kit w/Gasket
	7204362	Gasket only, single
	7336486	Gasket only, pack of 20
86	7146043	Screen
87	7167659	Screen Support
88	7170262	O-Ring, 1-1/8" x 1-3/8", single
	7336436	O-Ring, 1-1/8" x 1-3/8", pack of 20
89	7199729	Cap
90	7175199	Wave Washer
91	7171161	Valve Cover
92	7172997	Screw, #10 x 2-5/8" (8 req.)
93	7305150	Switch
94	7140738	Screw, #4-24 x 3/4" (2 req.)
95	7214383	Bypass Valve, 1" * (includes 2 ea. of Key Nos. 70 & 72)

* Not included with filter.

To order parts, call your local EcoWater dealer or go to www.ecowater.com to locate a dealer in your area.

LIMITED WARRANTY

EcoWater Systems LLC Advantage Warranty Series ETF2300AIV / EIV Water System

Congratulations! You have just purchased the highest quality water conditioning product on the market.

To whom is this warranty extended?

EcoWater Systems LLC warrants its products to the original owner and guarantees that the products will be free from defects in materials and workmanship from the original date of installation.

How does my warranty work?

If, during the respective warranty period, a part proves, after inspection by EcoWater, to be defective, EcoWater will, at its sole option repair or replace that part at no charge, other than normal shipping, installation or service charges.

What is covered by the warranty?

EcoWater Systems LLC guarantees that, for the LIFETIME of the original owner, the MINERAL TANK will not rust, corrode, leak, burst, or in any other manner fail to perform its proper functions, and that, for a period of SEVEN (7) YEARS after installation, the ELECTRONIC FACEPLATE will be free of defects in materials and workmanship and will perform its normal functions, and that, for a period of FIVE (5) YEARS after installation, the VALVE BODY will be free of defects in materials and workmanship and will perform its proper function, and that, for a period of ONE (1) YEAR after installation, ALL OTHER PARTS will be free of defects in materials and workmanship and will perform their normal functions.

How do I obtain warranty service?

Should you need service, your local, independent EcoWater Dealer is only a phone call away.

PHONE: _____

To obtain warranty service, notice must be given, within thirty (30) days of the discovery of the defect, to your local EcoWater Systems dealer.

If I need a part replaced after the factory warranty expires, is the replacement part warranted?

Yes, EcoWater Systems LLC warrants FACTORY REPAIRS as well as all REPLACEMENT PARTS for a period of 90 DAYS. This warranty does not include normal shipping, installation or service charges.

Are any additional warranties available?

We are pleased to say, YES! EcoWater Systems LLC sells an EXTENDED, PARTS ONLY WARRANTY for the ELECTRONICS portion of your product. This warranty is called the "Perfect 10" and extends the warranty on the electronic FACEPLATE, WIRING HARNESS, DRIVE MOTOR, POWER SUPPLY, POWER CORD, SENSOR HOUSING, and MICRO SWITCHES to a total of TEN (10) YEARS from the date of original installation. Your local dealer will provide details regarding this warranty or will refer you to the factory for additional information. Should your local dealer not offer this warranty, you may contact the factory for additional information.* This guarantee may be subject to normal shipping and installation or service charges.

General Provisions

The above warranties are effective provided the water filter is operated at water pressures not exceeding 125 psi, and at water temperatures not exceeding 120°F; provided further that the water filter is not subject to abuse, misuse, alteration, neglect, freezing, accident or negligence; and provided further that the water filter is not damaged as the result of any unusual force of nature such as, but not limited to, flood, hurricane, tornado or earthquake. EcoWater Systems LLC is excused if failure to perform its warranty obligations is the result of strikes, government regulation, materials shortages, or other circumstances beyond its control.

*THERE ARE NO WARRANTIES ON THE WATER FILTER BEYOND THOSE SPECIFICALLY DESCRIBED ABOVE. ALL IMPLIED WARRANTIES, INCLUDING ANY IMPLIED WARRANTY OF MERCHANTABILITY OR OF FITNESS FOR A PARTICULAR PURPOSE, ARE DISCLAIMED TO THE EXTENT THEY MIGHT EXTEND BEYOND THE ABOVE PERIODS. THE SOLE OBLIGATION OF ECOWATER SYSTEMS LLC UNDER THESE WARRANTIES IS TO REPLACE OR REPAIR THE COMPONENT OR PART WHICH PROVES TO BE DEFECTIVE WITHIN THE SPECIFIED TIME PERIOD, AND ECOWATER IS NOT LIABLE FOR CONSEQUENTIAL OR INCIDENTAL DAMAGES. NO ECOWATER DEALER, AGENT, REPRESENTATIVE, OR OTHER PERSON IS AUTHORIZED TO EXTEND OR EXPAND THE WARRANTIES EXPRESSLY DESCRIBED ABOVE.

Some states do not allow limitations on how long an implied warranty lasts or exclusions or limitations of incidental or consequential damage, so the limitations and exclusions in this warranty may not apply to you. This warranty gives you specific legal rights, and you may have other rights which vary from state to state. This warranty applies to consumer-owned installations only.